

Primljen / Received: 10.1.2017.

Ispravljen / Corrected: 12.5.2019.

Prihvaćen / Accepted: 30.5.2019.

Dostupno online / Available online: 10.2.2020.

# Effectiveness of friction dampers on seismic response of structure considering soil-structure interaction

## Authors:



**Sanket S. Sanghai**, MCE

G. H. Raisoni College of Engineering, Nagpur  
Department of Civil Engineering  
[sanket.sanghai@raisoni.net](mailto:sanket.sanghai@raisoni.net)

Corresponding author



Prof. **Prashant Y. Pawade**, PhD. CE

G. H. Raisoni College of Engineering, Nagpur  
Department of Civil Engineering  
[prashant.pawade@raisoni.net](mailto:prashant.pawade@raisoni.net)

Research Paper

**Sanket S. Sanghai, Prashant Y. Pawade**

## Effectiveness of friction dampers on seismic response of structure considering soil-structure interaction

The effect of soil structure interaction (SSI) on a single degree of freedom system with and without friction damper is analysed in the paper. The structure with different mass, stiffness and soil conditions was prepared and analysed for ten different earthquake records. Using the non-linear time history analysis, the structural response of a single degree of freedom structure with varying slip load of friction damper was studied. It was observed that the performance of friction dampers is influenced by soil parameters. Also, it was established that an optimum slip load and stiffness of brace changes with respect to the type of soil.

### Key words:

friction damper, soil-structure interaction, slip load

Prethodno priopćenje

**Sanket S. Sanghai, Prashant Y. Pawade**

## Utjecaj tarnih prigušivača na seizmički odziv konstrukcije s obzirom na međudjelovanje konstrukcije i tla

U ovom se radu analizira utjecaj međudjelovanja konstrukcije i tla (SSI) na sustav s jednim stupnjem slobode, s tarnim prigušivačem i bez njega. Konstrukcija s različitim vrijednostima mase, krutosti i uvjeta tla pripremljena je i analizirana za deset različitih potresa. Na temelju nelinearnog proračuna s vremenskim zapisom, analiziran je odziv konstrukcije s jednim stupnjem slobode pri raznim vrijednostima kliznog opterećenja tarnog prigušivača. Utvrđeno je da parametri tla utječu na ponašanje tarnog prigušivača. Osim toga, uočeno je da se vrijednosti optimalnog kliznog opterećenja i krutosti ukruta mijenjaju ovisno o vrsti tla.

### Ključne riječi:

tarni prigušivač, međudjelovanje tla i konstrukcije, klizno opterećenje

Vorherige Mitteilung

**Sanket S. Sanghai, Prashant Y. Pawade**

## Einfluss des Reibungsdämpfers auf das seismische Verhalten von Konstruktionen in Bezug auf das Zusammenspiel von Konstruktion und Boden

In dieser Abhandlung wird der Einfluss des Zusammenspiels von Konstruktion und Boden (SSI) auf einen einzelnen Freiheitsgrad analysiert, mit und ohne Reibungsdämpfer. Eine Konstruktion mit unterschiedlichen Werten für Masse, Steifigkeit und Bodenbedingungen wurde vorbereitet und für zehn verschiedene Erdbeben analysiert. Aufgrund der nicht linearen Berechnung mit Zeitprotokoll wurde das Verhalten der Konstruktion mit einem Freiheitswert bei unterschiedlichen Werten der Gleitlast des Reibungsdämpfers analysiert. Festgestellt wurde, dass die Bodenparameter Einfluss auf das Verhalten des Reibungsdämpfers haben. Außerdem wurde festgestellt, dass die Werte der optimalen Gleitlast und der steifen Festigkeit mit der Bodenart variieren.

### Schlüsselwörter:

Reibungsdämpfer, Zusammenspiel von Boden und Konstruktion, Gleitlast

### 1. Introduction

Nowadays, passive control devices are widely used for seismic response control. Among the various energy dissipation devices, a friction damper (FD) is a temperature independent device. The rectangular hysteresis loops of these devices give the maximum energy dissipation compared to other devices. Many studies concerning the effect of friction dampers on seismic response control of structures have so far been conducted. Pall and Marsh [1] studied an existing 9 story steel MRF (Moment Resisting Frame) modified using a friction damped bracing. It was observed that the friction damped braced frame behaves in a nonlinear fashion avoiding the yield in frame members. Filiatrault and Cherry [2] tested a three-storey frame equipped with friction dampers on a shake table which resulted in no damage even with an earthquake record having PGA (Peak Ground Acceleration) of 0.9g. Moreschi and Singh [3] discussed optimum-design friction dampers. After tests and analytical studies, it was observed that the effectiveness of these devices depends upon optimum design parameters, i.e. the slip load level and brace stiffness. Fallah and Honarparast [4] investigated optimum slip loads of Pall friction dampers. The optimization procedure based on NSGA-II was used to satisfy the objectives. Similarly, Naveet Kaur *et al.* [5], Haider and Kim [6], Marianchik *et al.* [7] and Min *et al.* [8] studied the effect of friction dampers on seismic response

of structures. It was observed that slip load plays an important role in the effectiveness of friction dampers. However, most previous studies were carried out with the assumption of rigid foundations, and they neglected the effect of soil-structure interaction on seismic response of structures. Actually, many structures are built in difficult soil conditions where proper consideration should be given to the interaction between the soil and structure. Farhang *et al.* [9] discussed an effective approach to estimate an accurate damping system for SSI (Soil-Structure Interaction) systems, which helped in determining the influence of soil. Datta *et al.* [10] studied flexibility of the supporting soil medium which allows movement of foundations. Chore and Ingle [11] reviewed the soil-structure interaction of framed structures and the problems related to pile foundations. Hosseinzadeh *et al.* [12] studied the dynamic soil-structure interaction effects on the seismic response of building structures with the surface and embedded mat foundations using shake table tests on scaled models. Many authors considered the effect of dynamic soil-structure interaction on the performance of structures [13-17]. These studies have shown that consideration of the SSI effect modifies dynamic characteristics of a structure, including frequencies, damping, mode shapes, etc. So, the performance of friction dampers will be affected by SSI effect. If SSI is neglected, friction dampers might be improperly applied to a structure due to overestimation or underestimation of structural response.

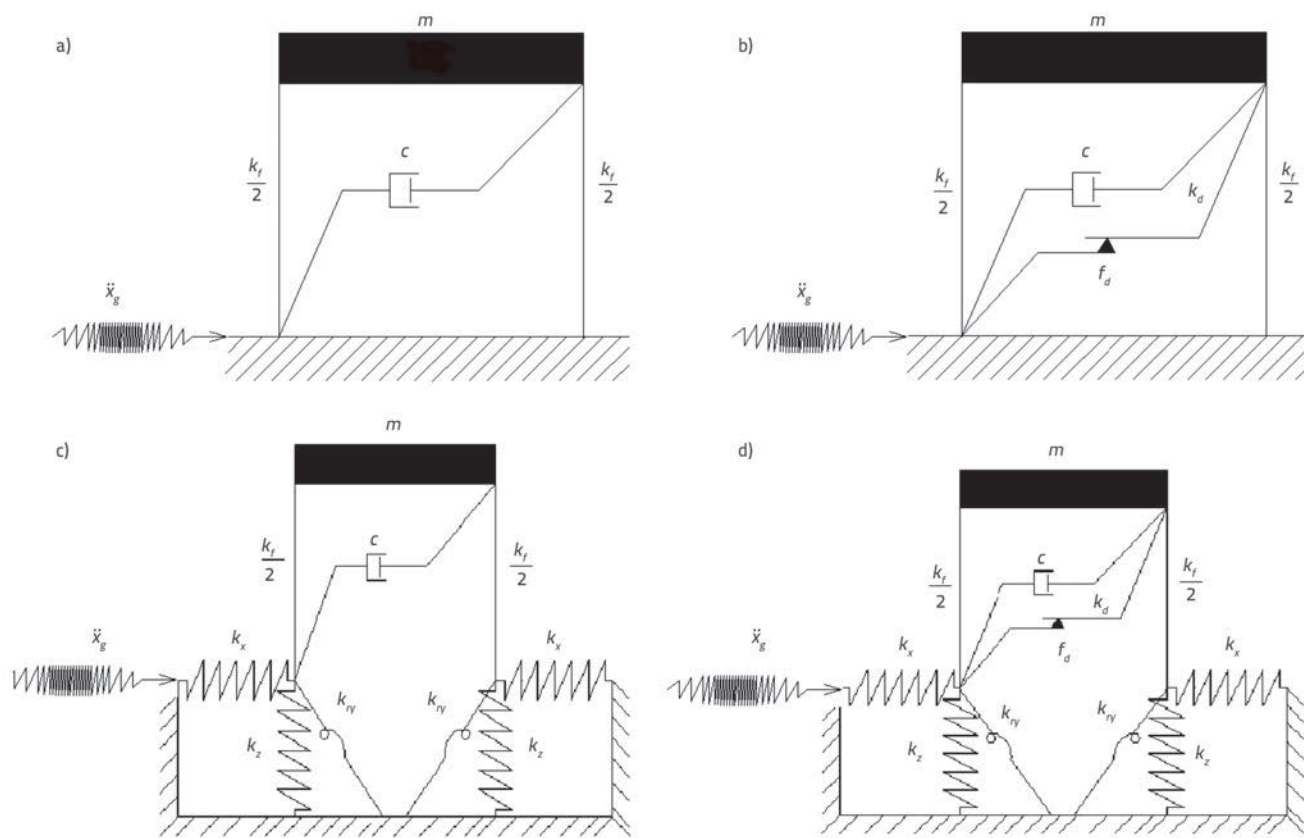

Figure 1. Mathematical models: a) bare frame without SSI; b) FD frame without SSI; c) bare frame with SSI; d) FD frame with SSI

Therefore, it is very important to carry out the research on the performance of friction dampers with SSI effects. In this paper, a SDOF system is chosen to investigate the effectiveness of friction dampers at varying soil characteristics.

## 2. Problem definition

The equations of motion of an SDOF structure with passive energy dissipation devices subjected to ground excitations at its base can be written as:

$$m\ddot{x}(t) + c\dot{x}(t) + k_f x(t) + f_d \operatorname{sgn} \dot{x}(t) = -m\ddot{x}_g(t) \quad (1)$$

where  $m$ ,  $c$ , and  $k_f$  are the mass, viscous damping constant, and stiffness of a system, respectively;  $x(t)$ ,  $\dot{x}(t)$  and  $\ddot{x}(t)$  are the displacement, velocity, and acceleration of the system, respectively;  $f_d$  and  $m\ddot{x}_g(t)$  are the friction force of a damper and external loading, respectively,  $\operatorname{sgn}\dot{x}(t)$  is the symbolic function defined as  $-1$ ,  $0$  and  $1$ , respectively in case  $\dot{x}(t) < 0$ ,  $\dot{x}(t) = 0$  i  $\dot{x}(t) > 0$  [8, 24]. The exact solution of Eq. (1) is dependent on the form of external load. For the current study, four different types of models are considered. Two models are prepared without the friction damper with fixed supports and soil modelled as springs, and two models are with friction damper with fixed supports and soil modelled as springs as shown in Figure 1.

### 2.1. Idealization of structure

A single bay single storey RC frame as shown in Figure 2 is considered in the present study. It is then converted into a lumped mass system after calculating stiffness and mass using basics of structural dynamics. The modulus of elasticity is calculated as per IS 456:2000 since M20 (correlates with compressive strength class C16/20 according to European standard EN 206) grade of concrete is used. The self weight of beams and columns is considered to be zero while the imposed load is used as the mass source. The size of beam and column is taken as 230 mm x 300 mm, with the bay width and storey height as 3 m. A rigid diaphragm model with one translational degree of freedom is considered for structural idealisation. The mass of the system ( $m$ ) is lumped at the floor level. The supporting columns provide stiffness ( $k_f$ ), and the inherent damping ( $c$ ) is considered as 5%.

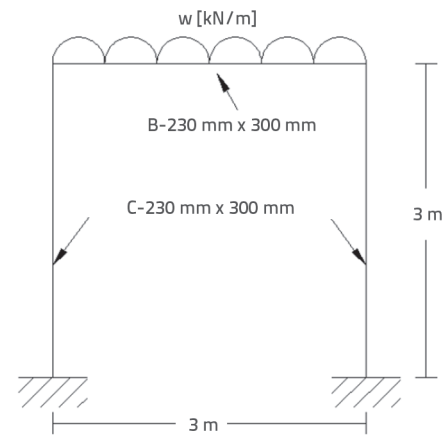

Figure 2. RC frame considered for study

The properties of SDOF system calculated from RC frame are as shown in Table 1.

Table 1. Properties of SDOF system

Imposed load as UDL( $w$ ) [kN/m]	20	25	30
Mass of system ( $m$ ) [kNs <sup>2</sup> /m]	6.116	7.648	9.174
Equivalent stiffness of frame ( $k_f$ ) [kN/m]	16333.33		
Inherent damping ( $c$ )	5% of critical		

### 2.2. Idealization of soil

The sizes of foundation are calculated from the safe bearing capacity of soil using the properties as given in Table 2. The soil is modelled using three translational springs ( $k_x$ ,  $k_y$  and  $k_z$ ) and three rotational springs ( $k_{rx}$ ,  $k_{ry}$  and  $k_{rz}$ ) as shown in Figure 1. A lot of research [18, 19] has been conducted for the evaluation of stiffness of such springs. The expressions for such spring stiffness, as stated in literature [19], are given in Table 3. The same approach is used as in the earlier studies [10, 20]. The empirical relationship  $G = 12870 \cdot N^{0.8}$  kN/m<sup>2</sup> [10, 21], where  $N$  is the number of blows to be applied in standard penetration test (SPT), is used for the calculation of shear modulus ( $G$ ). The Poisson's ratio is assumed as 0.5 for all types of soil conditions.

Table 2. Details of soil parameters chosen from literature [22, 23] and used elsewhere [10, 20]

Type of soil	N value	C [kN/m <sup>2</sup> ]	$\phi$ [°]	$\gamma_{\text{sat}}$ [kN/m <sup>3</sup> ]	$C_c$	$e_0$
Very soft	1	9.8	0.0	13.5	0.279	1.2
Soft	3	18.5	0.0	17.0	0.189	0.90
Medium	6	36.8	0.0	18.5	0.135	0.72
Stiff	12	73.5	0.0	19.4	0.12	0.67

N - value obtained from SPT, C - cohesion value,  $\phi$  - internal friction angle,  $\gamma_{\text{sat}}$  - density in saturated condition,  $C_c$  - compression index,  $e_0$  - initial void ratio of soil

**Table 3. Expressions for stiffness of equivalent springs along various degrees of freedom as available in literature [19] and used elsewhere [10, 20]**

Degrees of freedom	Stiffness of equivalent soil spring
Vertical	$[2GL/(1-\nu)](0.73+1.54\chi^{0.75})$ where $\chi=A_b/4L^2$
Horizontal (lateral direction)	$[2GL/(2-\nu)](2+2.50\chi^{0.85})$ where $\chi=A_b/4L^2$
Horizontal (longitudinal direction)	$[2GL/(2-\nu)](2+2.50\chi^{0.875})-[0.2/(0.75-\nu)]GL[1-(B/L)]$ where $\chi=A_b/4L^2$
Rocking (about the longitudinal)	$[G/(1-\nu)]I_{bc}^{0.75}(L/B)^{0.25}[2.4+0.5(B/L)]$
Rocking (about the lateral)	$[3G/(1-\nu)]I_{by}^{0.75}(L/B)^{0.15}$
Torsion	$3.5G I_{bz}^{0.75}(B/L)^{0.4}(I_{bz}/B^4)^{0.2}$

$A_b$  - area of foundations considered;  $B$  i  $L$  - half width and half length of rectangular foundations;  $I_{bx}$ ,  $I_{by}$ , and  $I_{bz}$  - moment of inertia of the foundation area with respect to longitudinal, lateral and vertical axes

**2.3. Idealization of friction damper**

The modelling of the friction damper (FD) was made according to assumptions made in the Coulomb’s law of friction [24]. Wen’s model [25] was used to model the friction damper as the behaviour of friction damper is elastoplastic in nature.

**Table 4. Properties of friction damper**

Slip load ( $f_s$ ) [kN]	5	10	15	20	25	30
Stiffness of brace ( $k_b$ ) [kN/m]	47140 (ISLC100)		64442 (ISLC125)		86550 (ISLC150)	
Post yield stiffness ratio	0.0001					
Yielding exponent	10					

**Table 5. Earthquake records used for analysis**

Sr. No.	Earthquake	PGA	Duration	Sr. No.	Earthquake	PGA	Duration
1.	El Centro EQ	0.313 g	40.00 s	6.	Dharmshala EQ	0.175 g	16.18 s
2.	Kobe EQ	0.344 g	40.90 s	7.	Kocaeli EQ	0.349 g	34.96 s
3.	Uttarkashi EQ	0.252 g	36.16 s	8.	Parkfield EQ	0.357 g	30.33 s
4.	Bhuj EQ	0.106 g	133.53 s	9.	Hollister EQ	0.198 g	39.93 s
5.	Loma Prieta EQ	0.367 g	39.90 s	10.	Northridge EQ	0.568 g	39.88 s

Only the nonlinearity of friction damper was considered, while the rest of the system members were assumed to be elastic in behaviour. The slip load ( $f_s$ ) and stiffness of brace ( $k_b$ ) were used for friction damper modelling. The friction dampers were fitted in three different types of steel sections ISLC100, ISLC125 & ISLC 150. The stiffness of brace section was calculated from steel section properties given in the Indian Steel Table. The properties of friction damper used in the present study are shown in Table 4.

**2.4. Analysis method**

The modal analysis was conducted to find the fundamental time period of the systems. The time-stepping solution method was used to plot behaviour of the friction damper. Ground motion records of ten earthquakes were used for the non-linear time history analysis. The properties of earthquake records are as given in Table 5, and the response spectra are plotted as shown in Figure 3.

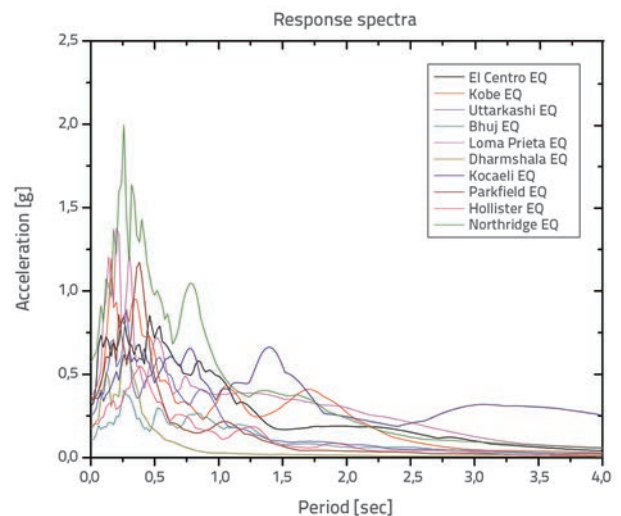

**Figure 3. Response spectra of EQ considered**

**3. Results and discussion**

Previous studies have shown that the soil-structure interaction plays a governing role in the seismic response of structures. So, the behaviour of structures during earthquakes can be totally misunderstood if this effect is

Table 6. Fundamental time period of SDOF structure

Parameters Type of frame	Mass [kNs <sup>2</sup> /m]	Stiffness [kN/m]	Fundamental time period [s]				
			Without SSI	With SSI			
				Stiff soil	Medium soil	Soft soil	Very soft soil
Bare frame	6.116	16333.33	0.124	0.126	0.127	0.131	0.140
	7.648	16333.33	0.138	0.141	0.142	0.146	0.157
	9.174	16333.33	0.152	0.155	0.156	0.160	0.172
FD frame	6.116	38290	0.079	0.084	0.087	0.093	0.109
	7.648	38290	0.089	0.094	0.097	0.104	0.122
	9.174	38290	0.097	0.103	0.107	0.114	0.133

neglected in the analysis. Also, friction dampers are widely used and designed for improving the seismic response while neglecting this effect. Thus, mainly three parameters, e.g. peak base shear, peak top floor displacement, and % of energy dissipation, are discussed to find the influence of soil-structure interaction on the performance of friction dampers. The main objective of this study is to minimize the peak base shear and displacement while maximizing the energy dissipation. For determining the optimum range of slip load and brace stiffness, the following three functions were considered for various soil conditions:

$$f_1 = \text{minimize} \left( \frac{R_{max,c}}{R_{max,u}} \right) \quad (2)$$

$$f_2 = \text{minimize} \left( \frac{u_{max,c}}{u_{max,u}} \right)_{top} \quad (3)$$

$$f_3 = \text{maximize} \left( \frac{E_{max,c}}{E_{max,u}} \right) \quad (4)$$

where  $R_{max,c}$ ,  $u_{max,c}$ , and  $E_{max,c}$  are the peak base shear, peak floor displacement, and hysteretic energy after damper installation, respectively, while  $R_{max,u}$ ,  $u_{max,u}$  and  $E_{max,u}$  are the peak base shear, peak floor displacement, and input energy before damper installation, respectively. A similar approach was used by Fallah and Honarparast [4], Vaseghi *et.al.* [26] and Lee *et.al.* [27].

### 3.1. Fundamental time period

A modal analysis was performed to check the effect of soil-structure interaction and friction damper on fundamental time period of structures. The corresponding results are shown in Table 6 below. The table presents the mass and stiffness

of systems. For bare frame, the stiffness is calculated from columns while for the friction damped frame, the effective stiffness is calculated from columns with added stiffness from brace section.

The Fundamental time period for SDOF structure with and without SSI effect is shown in Table 6. It can be observed that, as compared to bare frame, the time period in the friction damped frame decreases with an increase in the stiffness of brace. However, it should also be noted that the time period increases as the soil beneath the structure becomes softer. This indicates that even lower stiffness of brace also performs well when SSI effect is not considered. However, its performance is surely affected when SSI effect is taken into account.

### 3.2. Objective function values

#### 3.2.1. Objective function related to peak base shear

The target of objective function  $f_1$  is to minimize the value of peak base shear. The results related to peak base shear are shown in Figure 4, Figure 5, and Figure 6 for the system with various mass values: 6.116 kNs<sup>2</sup>/m, 7.648 kNs<sup>2</sup>/m, and 9.174 kNs<sup>2</sup>/m. However, the stiffness remains constant at 38290 kN/m.

The values of objective function ( $f_1$ ), which is aimed to minimize the peak base shear, are shown in Figure 4, Figure 5, and Figure 6. The results show that the minimum value of objective function lies between the slip load of 10kN to 15kN. However, for higher PGA earthquakes, the slip load value reaches up to 25 kN. It can therefore be stated that the optimum range changes slightly depending on earthquake intensity and change in mass. But, there is a major change when SSI effect is considered. As the soil becomes softer, the effectiveness of the friction damper with optimum slip load decreases. This indicates that the influence of soil should be considered while designing friction dampers.

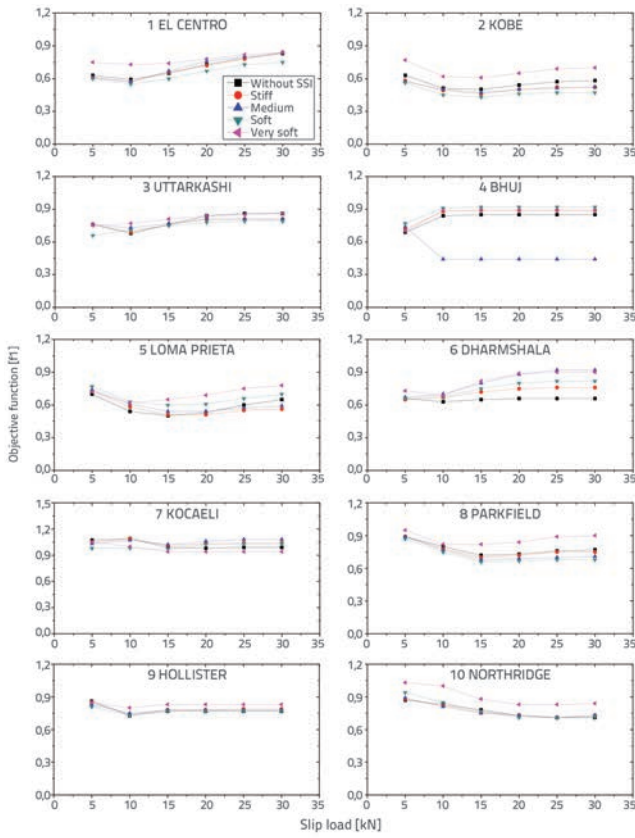

Figure 4. Objective function ( $f_1$ ):  $m = 6.116 \text{ kNs}^2/\text{m}$ ,  $k = 38290 \text{ kN/m}$

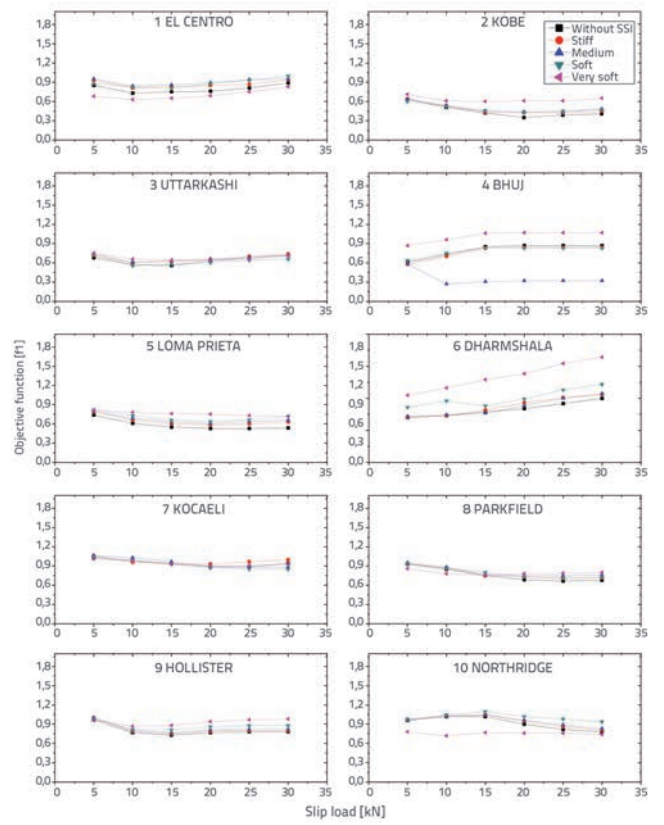

Figure 6. Objective function ( $f_1$ ):  $m = 9.174 \text{ kNs}^2/\text{m}$ ,  $k = 38290 \text{ kN/m}$

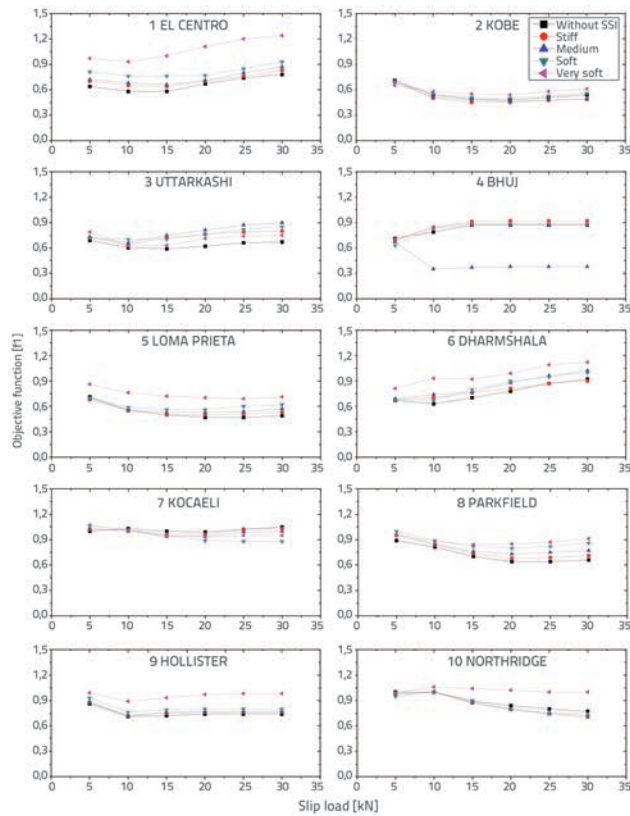

Figure 5. Objective function ( $f_1$ ):  $m = 7.648 \text{ kNs}^2/\text{m}$ ,  $k = 38290 \text{ kN/m}$

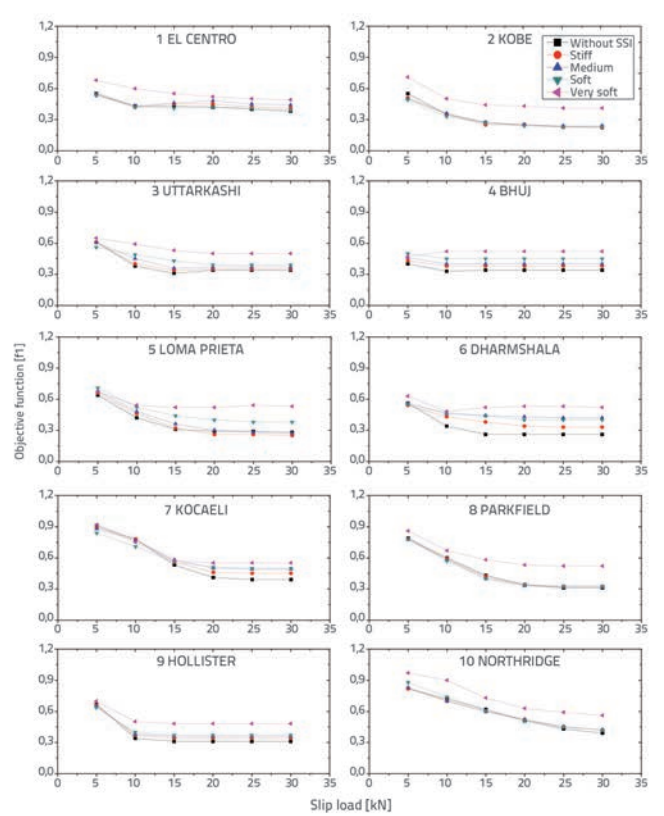

Figure 7. Objective function ( $f_1$ ):  $m = 6.116 \text{ kNs}^2/\text{m}$ ,  $k = 38290 \text{ kN/m}$

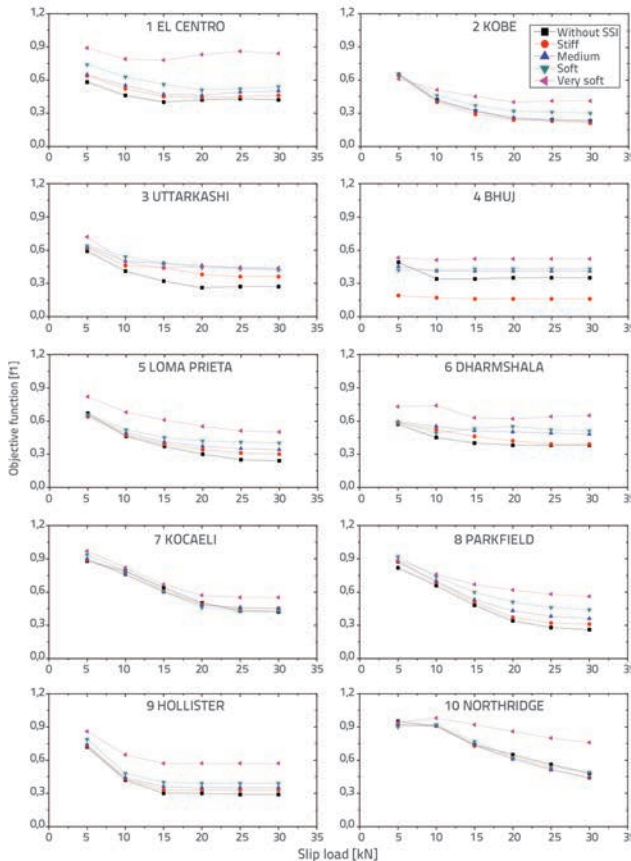

Figure 8. Objective function ( $f_2$ ):  $m = 7.648 \text{ kNs}^2/\text{m}$ ,  $k = 38290 \text{ kN/m}$

### 3.2.2. Objective function related to peak floor displacement

The target of objective function  $f_2$  is to minimize the value of peak floor displacement. A SDOF system with mass values of  $6.116 \text{ kNs}^2/\text{m}$ ,  $7.648 \text{ kNs}^2/\text{m}$  and  $9.174 \text{ kNs}^2/\text{m}$ , and with the constant stiffness of  $38290 \text{ kN/m}$ , is considered for studying this parameter. The variations of objective function  $f_2$  are shown in Figure 7, Figure 8, and Figure 9

The values of objective function  $f_2$ , which is aimed at minimizing the peak top floor displacement, are shown in Figure 7, Figure 8, and Figure 9. The function value decreases with an increase in slip load of friction damper. It is clear that the function value will decrease due to increase in slip load, because the structure is becoming stiffer. The optimum slip load range for this parameter can be taken as  $10 \text{ kN}$  to  $15 \text{ kN}$ , as the friction damper is not slipping for later slip loads. As the axial force in friction damper does not exceed the slip load value, the damper acts as a bracing member. This can be correlated with an increase in peak base shear after an optimum range of slip load. Again it can be seen that the function value increases with the softness of soil in every case for the same slip load. This surely confirms the influence of soil on the performance of friction damper.

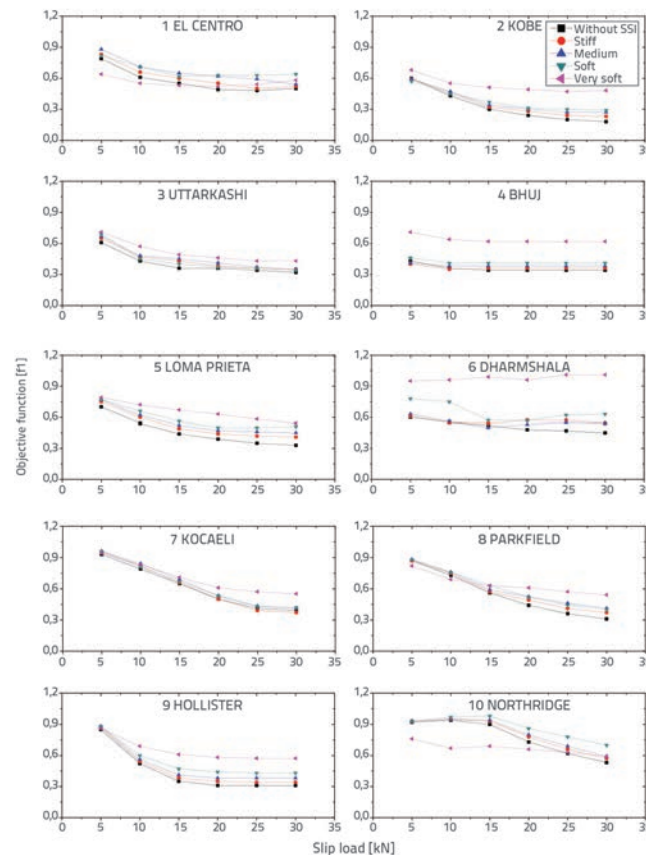

Figure 9. Objective function ( $f_2$ ):  $m = 9.174 \text{ kNs}^2/\text{m}$ ,  $k = 38290 \text{ kN/m}$

### 3.2.3. Objective function related to energy dissipation

The objective function  $f_3$  is aimed at maximizing the percentage of energy dissipation. Again, a SDOF system with mass values of  $6.116 \text{ kNs}^2/\text{m}$ ,  $7.648 \text{ kNs}^2/\text{m}$ , and  $9.174 \text{ kNs}^2/\text{m}$ , and with constant stiffness of  $38290 \text{ kN/m}$ , is taken for studying this parameter. Variations of objective function  $f_3$  are shown in Figure 10, Figure 11, and Figure 12.

Earthquake forces induce input energy into a structure which has to dissipate the energy through modes. But, due to supplemental damping provided by friction damper, most part of input energy is dissipated through friction. Dissipation of input energy by friction dampers is presented in Figure 10, Figure 11, and Figure 12. The results show that the energy dissipation by friction dampers is higher for an optimum range of slips loads for which the peak base shear is minimum. The optimum range of slip loads for friction damper is once again  $10 \text{ kN}$  to  $15 \text{ kN}$ . In addition, the stiffness of brace plays an important role in dissipation. It can be observed that different intensity earthquakes induce different amounts of input energy in the structure, and so the same friction damper may perform differently in each particular case. Also, it was observed that the dissipation capacity of friction dampers is greatly affected when soil parameters come into frame. The effectiveness of friction damper is influenced by soil–structure interaction.

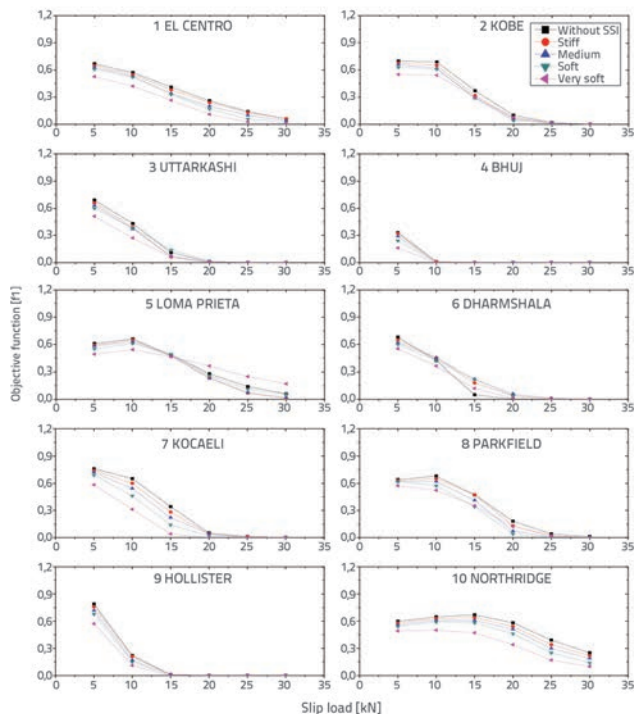

Figure 10. Objective function ( $f_3$ ):  $m = 6.116 \text{ kNs}^2/\text{m}$ ,  $k = 38290 \text{ kN/m}$

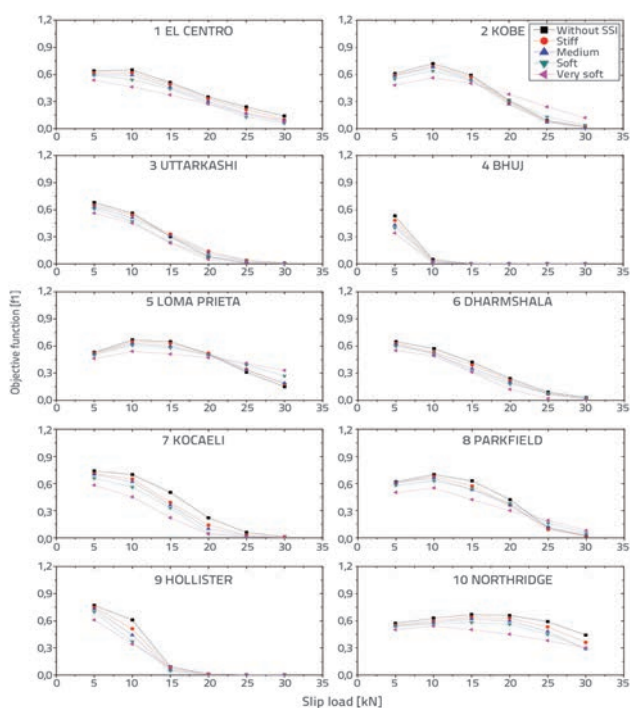

Figure 11. Objective function ( $f_3$ ):  $m = 7.648 \text{ kNs}^2/\text{m}$ ,  $k = 38290 \text{ kN/m}$

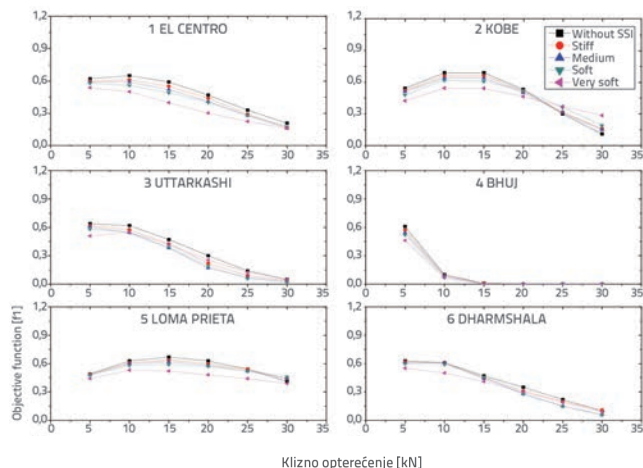
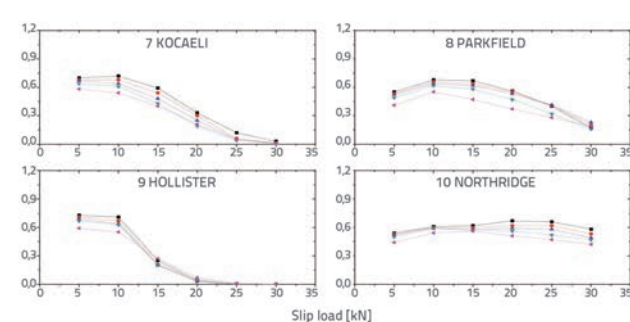

Figure 12. Objective function ( $f_3$ ):  $m = 9.174 \text{ kNs}^2/\text{m}$ ,  $k = 38290 \text{ kN/m}$



### 3.3. Comparison of response by varying stiffness of brace

To compare the effect of stiffness, three types of sections were used for bracing. The effect on peak base shear, peak floor displacement, and energy dissipation capacity of friction damper was studied.

The study was carried out for three different stiffnesses of braces and three different masses using ten different seismic records. The corresponding stiffness variation results are shown in Figure 13, Figure 14 and Figure 15 for  $m = 7.648 \text{ kNs}^2/\text{m}$ . Figure 13 gives a function value comparison for peak

base shear with variations in brace stiffness. The purpose of this study was to check the effect of brace stiffness on response of structures. The graphs show that the change in brace stiffness significantly affects the response of structure when the SSI effect is considered.

Figure 14 gives function value comparison for peak floor displacement with variations in brace stiffness. The stiffness of structure increases with an increase in brace stiffness. Hence, this will absolutely reduce the floor displacement. This reduction can be seen clearly from the graphs. The difference also reduces as soil becomes softer. Figure 15 gives function value comparison for energy dissipation by friction damper



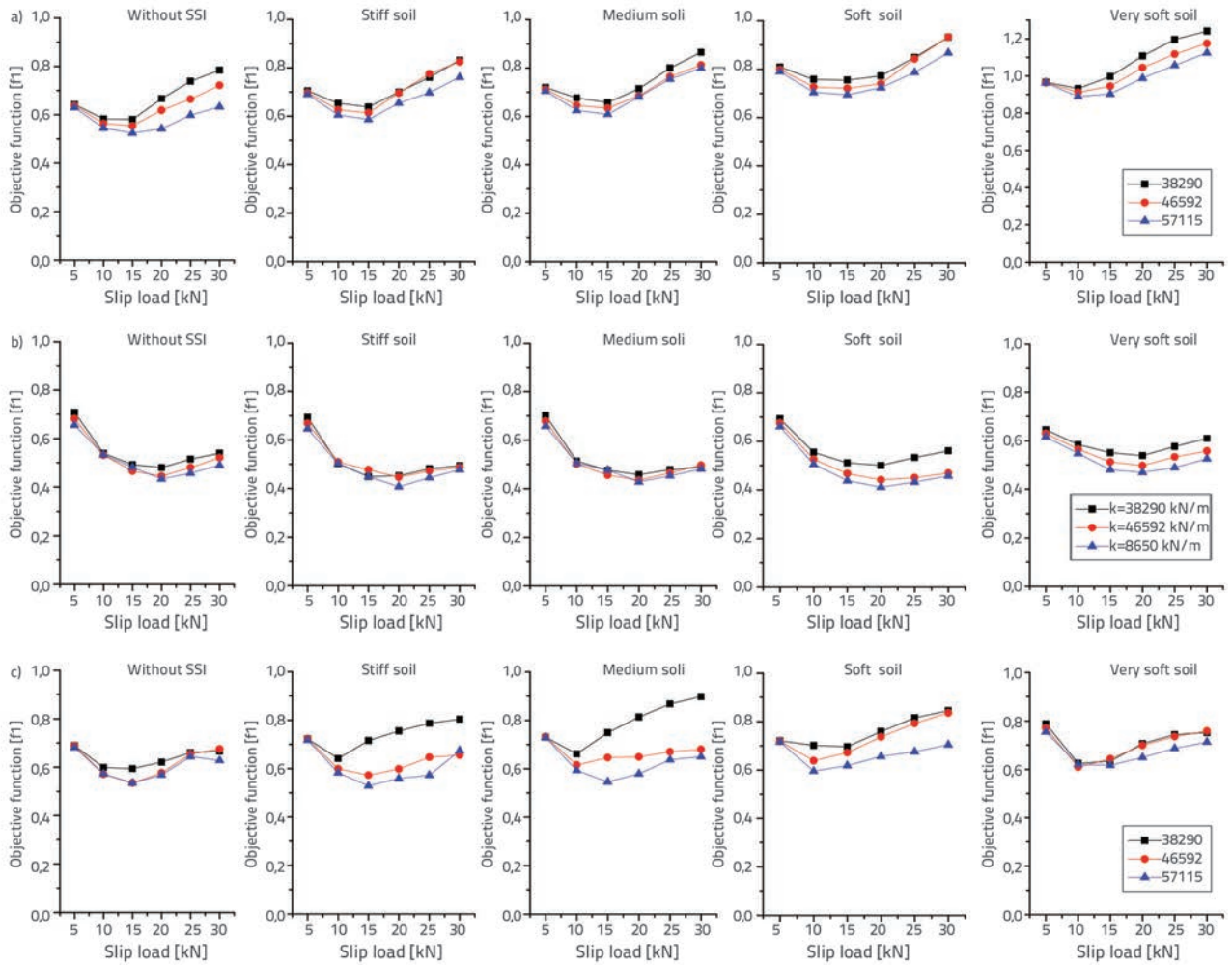

Figure 13. Function value of peak base shear for: a) El Centro; b) Kobe; c) Uttarkashi Ground Motion with  $m = 7.648 \text{ kNs}^2/\text{m}$

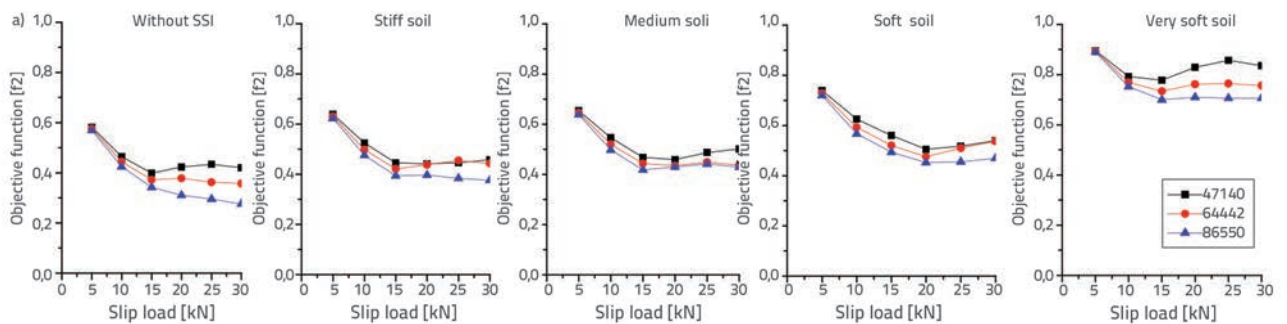

Figure 14. Function value of peak floor displacement for: a) El Centro; b) Kobe; c) Uttarkashi Ground Motion with  $m = 7.648 \text{ kNs}^2/\text{m}$

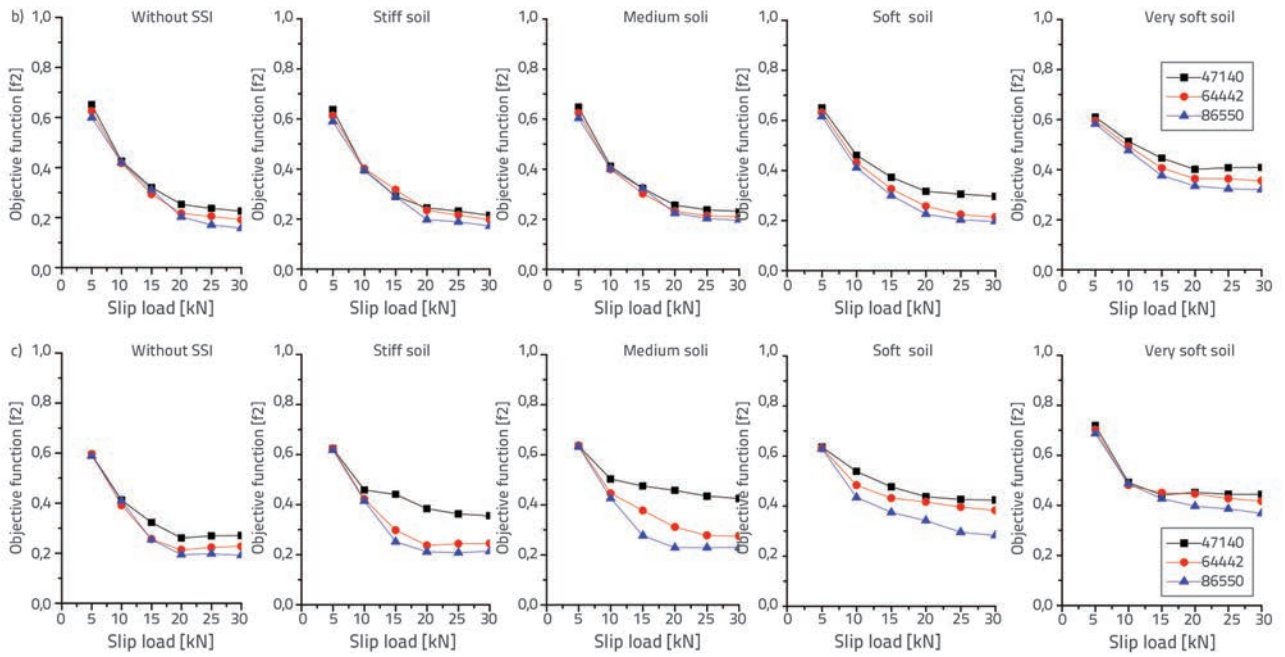

Figure 14. Function value of peak floor displacement for: a) El Centro; b) Kobe; c) Uttarkashi Ground Motion with  $m = 7.648 \text{ kNs}^2/\text{m}$

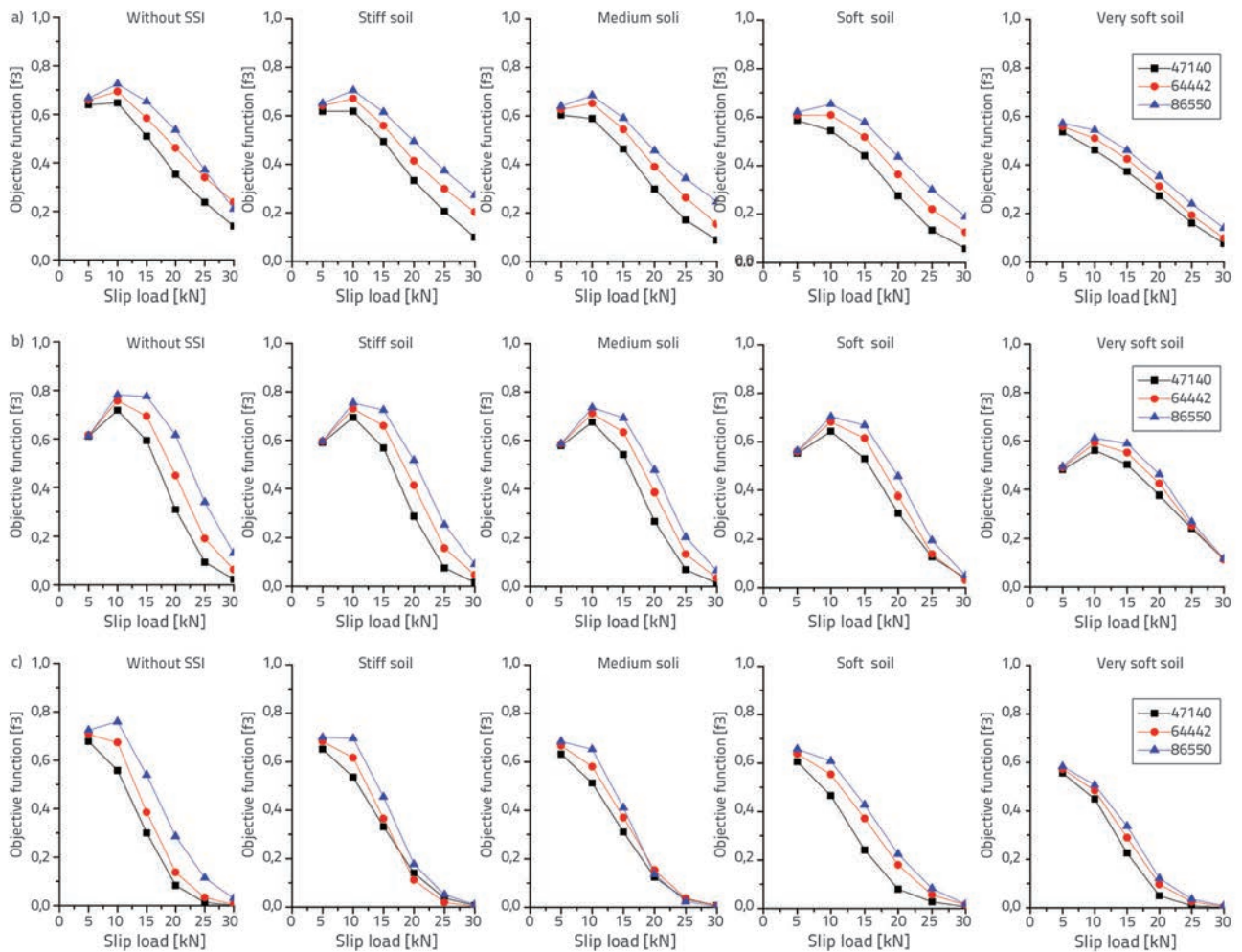

Figure 15. Function value of energy dissipation for: a) El Centro; b) Kobe; c) Uttarkashi Ground Motion with  $m = 7.648 \text{ kNs}^2/\text{m}$

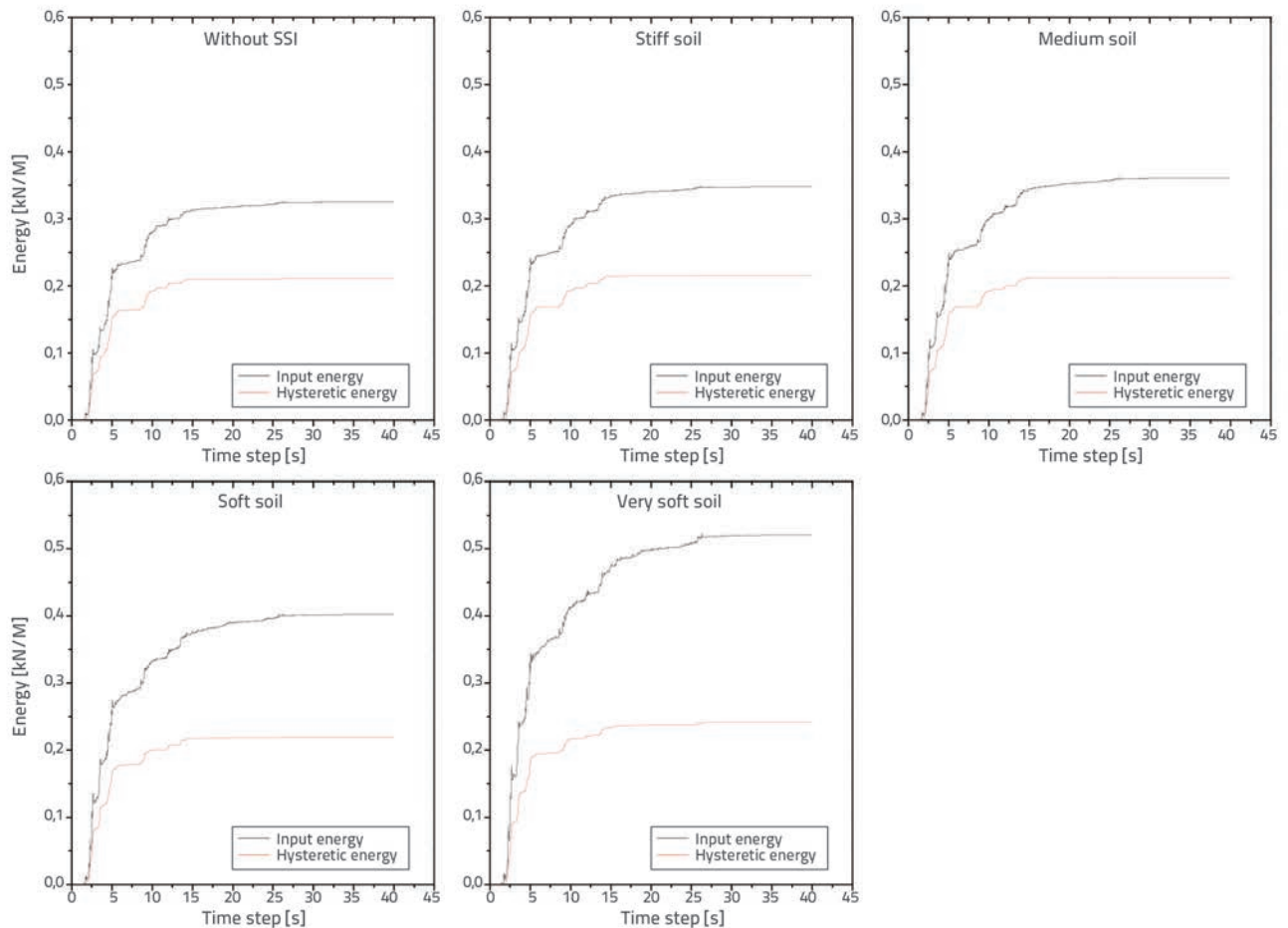

Figure 16. Comparison between input & hysteretic energy of friction damper with slip load = 10 kN and with  $m = 7.648 \text{ kNs}^2/\text{m}$ ,  $k = 38290 \text{ kN/m}$ , with and without SSI conditions

with variations in brace stiffness. As energy dissipation is the main governing criteria for providing dampers in the structure, it is necessary to check the effect of change in brace stiffness. The results show that the change in brace stiffness does not greatly affect the energy dissipation capacity of friction dampers.

### 3.4. Comparison of energy with friction damper

The comparison of all the three objective functions shows that base shear and floor displacement are related to energy dissipation by friction damper. The energy dissipation capacity of friction dampers depends upon hysteretic energy. Figure 16 shows the plots of input and hysteretic energy for a friction damper with slip load of 10 kN in SDOF system, with the mass of  $7.648 \text{ kNs}^2/\text{m}$  and the stiffness of  $38290 \text{ kN/m}$ , for El Centro earthquake.

The energy dissipation by friction damper is dependent on the area of hysteresis loop. Hence, to check the input energy in structure and energy dissipated by friction damper, one case is considered for the friction damper with Slip Load = 10kN and

with  $m = 7.648 \text{ kNs}^2/\text{m}$ ,  $k = 38290 \text{ kN/m}$ , with and without SSI conditions, as shown in Figure 16. Figure 16 shows that the input energy in a structure varies drastically with the softness of soil, while the energy dissipated by friction damper remains nearly the same. Therefore, the performance of friction damper reduces as it is not able to cope with seismic demand of the structure when the soil-structure interaction is considered.

## 4. Conclusions

The study of performance of friction dampers was conducted by taking into account the soil-structure interaction. The study was carried out by varying mass, stiffness, slip load, and soil conditions for ten different earthquake records. It was established that the response of friction dampers is affected by SSI effects. The following conclusions can be made:

- The fundamental time period of the structure increases with an increase in softness of the ground surface beneath the structure.
- The effectiveness of friction damper in controlling time period of structure also reduces due to SSI.

- It can be concluded from the objective functions of peak base shear, peak floor displacement, and energy dissipation, that the friction damper does not achieve the expected response when the soil surface becomes softer.
- An optimum range of slip load changes with the change of soil.
- The effect of brace stiffness in energy dissipation is not highly significant. However, an optimum brace stiffness should be provided to avoid the yielding of brace during earthquakes.

## REFERENCES

- [1] Pall, A.S., Marsh, C.: Response of Friction Damped Braced Frames, *Journal of the Structural Division, American Society of Civil Engineers*, 108 (1982) ST6.
- [2] Filiatrault, A., Cherry, S.: Performance Evaluation of Friction Damped Braced Steel Frames under Earthquake Loads, *Earthquake Spectra*, 3 (1987) 1, pp. 57-78.
- [3] Moreschi, L.M., Singh, M.P.: Design of Yielding and Friction Dampers for Optimal Seismic Performance, *Earthquake Engineering Structural Dynamics*, 32 (2003), pp. 1291-1311.
- [4] Fallah, N., Honarparast, S.: NSGA-II based multi-objective optimization in design of Pall friction dampers *Journal of Constructional Steel Research*, 89 (2013), pp. 75-85.
- [5] Kaur, N., Matsagar V.A., Nagpal, A.K.: Earthquake Response of Mid-rise to High-rise Buildings with Friction Dampers, *International Journal of High-Rise Buildings*, 1 (2012) 4, pp. 311-332.
- [6] Haider, J.R., Kim, U.: A Parametric Approach for the Optimization of Passive Friction Dampers, *Structures Congress 2012* © ASCE 2012, pp. 1673-1684, 2012.
- [7] Marianchik, E., Levy, R., Rutenberg, A., Segal, F.: Optimal Seismic Design of Friction Damped Braced Frames Based on Existing Earthquake Records, *12WCEE*, 1-8, 2000.
- [8] Kyung-Won, M., Seong, J.Y., Kim, J.: Simple design procedure of a friction damper for reducing seismic responses of a single-story structure' *Engineering Structures*, 32 (2010), pp. 3539-3547.
- [9] Ostadan, F., Deng, N., Roesset, J.M.: Estimating Total System Damping for Soil-Structure Interaction Systems, *Proceedings Third UJNR Workshop on Soil-Structure Interaction*, Menlo Park, California, USA, 2004.
- [10] Dutta, S.C.; Bhattacharyya, K., Roy, R.: Response of low-rise buildings under seismic ground excitation incorporating soil-structure interaction, *Soil Dynamics and Earthquake Engineering*, 24 (2004), pp. 893-914.
- [11] Chore, H.S., Ingle, R.K.: Interaction analysis of building frame supported on pile group, *Indian Geotech. J.*, 38 (2008) 4, pp. 483-501.
- [12] Hosseinzadeh, N., Davoodi, M., Roknabadi, E.R.: Comparison of Soil-Structure Interaction Effects between Building Code Requirements and Shake Table Study, *JSEE, Spring*, 11 (2009) 1.
- [13] Petronijević, M., Nefovska Danilović, M., Radišić, M.: Analysis of frame structure vibrations induced by traffic, *GRADEVINAR*, 65 (2013) 9, pp. 811-824.
- [14] Penava, D., Kraus, I., Petronijević, M., Schmid, G.: Dynamic soil-structure analysis of tower-like structures using spectral elements, *Tehnički vjesnik*, 25 (2018) 3, pp. 738-747
- [15] Dominguez, J.: *Boundary elements in dynamics*. Wit Press, 1993.
- [16] Çelebi, E., Fırat, S., Çankaya, I.: The evaluation of impedance functions in the analysis of foundation vibrations using boundary element method. *Applied Mathematics and Computation*, 173 (2006) 1, pp. 636-667.
- [17] Pitilakis, D., Moderessi-Farahmand-Razavi, A., Clouteau, D.: Equivalent-linear dynamic impedance functions of surface foundations. *Journal of Geotechnical and Geoenvironmental Engineering*, 139 (2013) 7, pp. 1130-1139, [https://doi.org/10.1061/\(ASCE\)GT.1943-5606.0000829](https://doi.org/10.1061/(ASCE)GT.1943-5606.0000829) ."
- [18] Dobry, R., Gazetas, G.: Dynamic response of arbitrarily shaped foundations, *J GeotechEng, ASCE*, 112 (1986) 2, pp. 109-35.
- [19] Gazetas, G.: Formulas and charts for impedances of surface and embedded foundations, *J GeotechEng, ASCE*, 117 (1991) 9, pp. 1363-81.
- [20] Sekhar, C.D., Roy, R., Prithwish, K.D., Raghupati, R., Reddy, G.R.: Seismic safety of structures: Influence of soil-flexibility, asymmetry and ground motion characteristics, *Journal of Sound and Vibration*, 307 (2007), pp. 452-480.
- [21] Ohsaki, Y., Iwasaki, R.: On dynamic shear moduli and Poisson's ratio of soil deposits, *Soils Found*, 13 (1973) 4, pp. 61-73.
- [22] Bhattacharya, K., Dutta, S.C.: Assessing lateral period of building frames incorporating soil-flexibility, *Journal of Sound & Vibrations*, 269 (2004) 3-5, pp. 795-821.
- [23] Bhattacharya, K., Dutta, S.C., Dasgupta, S.: Effect of soil-flexibility on dynamic behaviour of building frames on raft foundation, *Journal of Sound & Vibrations*, 274 (2004), pp. 111-135.
- [24] Chopra, A.K.: *Dynamics of Structure*, Fourth Edition, Pearson Education, Inc.
- [25] *Software Verification Manual for SAP2000*, Computer Structures. Inc.
- [26] Vaseghi, J., Navaei, S., Navayinia, B., Roshantabari, F.: A Parametric Assessment of Friction Damper in Eccentric Braced Frame, *World Academy of Science, Engineering and Technology*, 58 (2009).
- [27] Sang-Hyun Lee, S.H., Parkb, J.H., Lee, S.K., Min, K.W.: Allocation and slip load of friction dampers for a seismically excited building structure based on storey shear force distribution, *Engineering Structures*, 30 (2008), pp. 930-940.