

Primljen / Received: 27.12.2022.

Ispravljen / Corrected: 18.4.2023.

Prihvaćen / Accepted: 5.5.2023.

Dostupno online / Available online: 10.9.2023.

# Bamboo as reinforcing material in concrete structures: A literature study

## Authors:



**M Sadique Ameen**, MCE

Visvesvaraya National Institute of Technology,  
India

[sadiqueameen007@gmail.com](mailto:sadiqueameen007@gmail.com)

Corresponding author



Assoc.Prof. **Debarati Datta**, PhD. CE

Visvesvaraya National Institute of Technology,  
India

[debaratidatta@apm.vnit.ac.in](mailto:debaratidatta@apm.vnit.ac.in)

Research paper - subject review

**M Sadique Ameen, Debarati Datta**

## Bamboo as reinforcing material in concrete structures: A literature study

The production of conventional building materials such as steel, concrete, and brick causes severe exploitation of natural resources and emission of greenhouse gases. Therefore, alternative eco-friendly, sustainable, and inexpensive building materials are required. Bamboo is a natural material which can replace steel in various structures. Several studies have evaluated the potential of bamboo as a steel replacement in structures. This paper provides a literature review on the use of bamboo-reinforced concretes (BRC) in various countries.

### Key words:

bamboo splints, structural members, prefabricated wall panels, chemical treatments, different codes, bamboo concrete bond

Pregledni rad

**M Sadique Ameen, Debarati Datta**

## Bambus kao armatura u betonskim konstrukcijama: pregled literature

Proizvodnja konvencionalnih građevnih materijala kao što su čelik, beton i opeka uzrokuje značajno iskorištavanje prirodnih resursa i emisiju stakleničkih plinova. Stoga je potrebna primjena alternativnih, ekološki prihvatljivih, održivih i jeftinih građevnih materijala. Bambus je prirodni materijal koji može zamijeniti čelik u raznim konstrukcijama. U nekim istraživanjima razmatran je potencijal bambusa kao zamjene za čelik u konstrukcijama. Ovaj rad pruža pregled literature o uporabi betona armiranog bambusom u različitim zemljama.

### Ključne riječi:

štapovi od bambusa, konstrukcijski elementi, predgotovljeni zidni paneli, kemijski tretmani, različite norme, veza bambus-beton

## 1. Introduction

Recently, construction of buildings and infrastructure projects are rapidly increasing. Owing to huge population growth in urban areas, there is a significant demand for homes, which has led to the exploitation of traditional natural resources. Concrete is widely used as construction material worldwide as it exhibits high compressive strength. However, it has very low tensile strength, which is only 10 % of its compressive strength. Owing to its poor tensile strength and brittleness, concrete requires tensile reinforcement, typically in the form of a steel rebar. Although steel works well with concrete, it has many disadvantages, including heavy weight, corrosion susceptibility, high cost, and ecological unfavorability. To overcome these drawbacks, numerous researchers are developing novel approaches to offer sustainable replacements for steel reinforcements. Bamboo is a potential replacement for steel in reinforced concrete owing to its mechanical properties and positive economic, social, and environmental impacts, particularly for low-cost structures in rural and urban areas.

In only a few months, bamboo reaches its entire growth potential, and within years, it reaches its maximum mechanical strength. Bamboo is known to have a 50 % lower longitudinal ultimate tensile strength than mild steel and it has a far higher specific tensile strength than cast iron, structural steel, aluminium alloys, wood, and concrete [1]. Bamboo is a useful alternative to steel reinforcement owing to its low weight, high tensile strength, and ability to regenerate, particularly in locations with easy access to locally produced bamboo. One of the most significant benefits of growing bamboo is its ability to absorb carbon dioxide. Therefore, it is also known as a carbon sink. In recent times, the rapid increase in global warming is of great concern. Bamboo can help reduce the ill effects of greenhouse gases and combat global warming.

The large-scale use of bamboo as a reinforcement material will lead to its increasing demand, consequently increasing its production, that is, cultivation. Live bamboo absorbs large amounts of CO<sub>2</sub> from air and releases O<sub>2</sub>, thereby purifying the atmosphere. However, steel production negatively affects the environment.

Mature bamboo can be cut, dried, and treated to make it suitable for use in construction. Thus, although dead bamboo has no atmospheric purifying effect, its production results in a greener environment.

According to Akwada and Akinlabi [2] bamboo plays a significant role in mitigating global climate change. China has one of the highest rates of carbon sequestration worldwide. It grows rapidly; thus, it produces a higher rate of oxygen than other equivalent stands

of trees. According to a report by Environmental Bamboo Foundation (2001), bamboo releases 35 % more oxygen than equivalent stands of trees, and sequesters up to 12 tonnes of carbon dioxide from the air per hectare per year.

Bamboo can significantly reduce greenhouse gas emissions, create jobs and thus produce high incomes for cultivators. Bamboo is a fast-growing plant with strong roots and rhizomes that improve soil stability. This indicates that it can stabilise and regenerate land, thereby preventing landslides. Its roots are highly effective in preventing soil erosion by firmly holding the soil together, thereby preventing soil loss.

Bamboo has several advantageous characteristics which render it a suitable building material. However, several shortcomings are also observed. Bamboo degrades faster than steel because it is a natural material. It has many species, the properties of which vary widely. Not all species are suitable as building materials. Therefore, cultivating suitable species is as important as their use for construction purposes. In addition, as natural materials, they are not uniform in size and shape. Despite these limitations, bamboo has been a popular research topic for years. These studies and their findings are categorised in this paper.

## 2. Early research

Chow [3] conducted the first documented investigation of bamboo usage as a reinforcing component in concrete at the Massachusetts Institute of Technology in 1914. The high tensile strength of bamboo has led researchers to conceive the idea of applying bamboo on the tension side of beams. Four beams were cast, two of which were tested under a single concentrated load at the centre, and the other two were tested under a two-point loading test 60 days after casting in a beam-testing machine, as shown in Figure 1. Results showed that the maximum load at which the steel beams and bamboo beams failed were 19.57 kN and 13.87 kN, respectively. The factor of safety for the ratio of the actual maximum load to the theoretical load was 3.2 for the steel beam and 2.3 for the bamboo beam with a concentrated

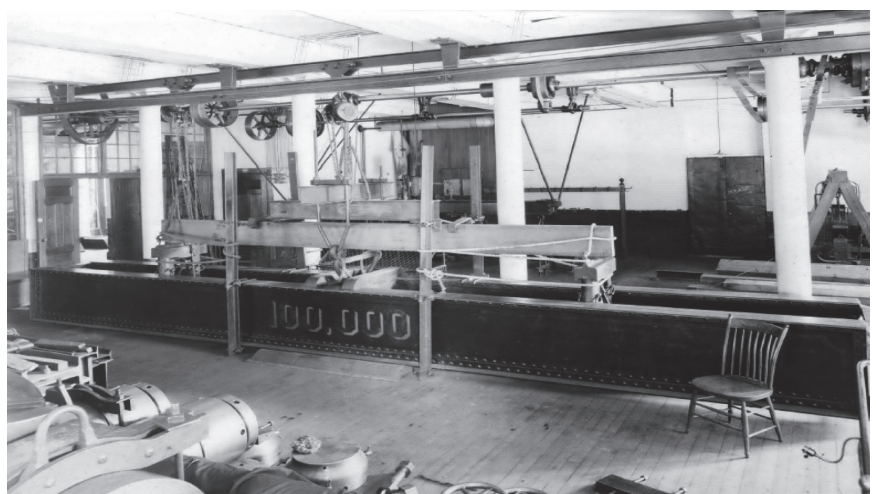

Figure 1. Beam testing machine [3]

load at the centre. For the second setup in which the beam was subjected to two-point-load, the maximum load at which the steel and bamboo beams failed were 30.69 kN and 20.46 kN, respectively, and factor of safety for actual load to expected load were 3.37 and 2.25 for the steel and bamboo beams, respectively.

It was concluded that the behaviour of bamboo resembled that of steel in concrete, and it may be used instead of steel for small structures. However, it has been suggested that more experimental data are required before designing bamboo beams in practice.

After Chow [3], the viability of employing bamboo as an alternative type of reinforcement in structural concrete has been tested by several researchers. For more than a century, many researchers have used bamboo to strengthen concrete constructions. In those studies, bamboo splints (semi-round strips) or bars (whole culms of moderate diameters) were used. In 1950, Glenn [4] led a study funded by the US War Production Board on bamboo-reinforced concrete (BRC), which included building experimental structures and conducting mechanical tests. From the test results, Glenn [4] came to numerous conclusions that helped in developing the design guidelines for the use of bamboo splints as reinforcements in concrete.

Glenn [4] noted the issues with BRC beams under loading, including significant deflection, limited ductility, and early brittle fractures. Furthermore, he discovered bonding problems caused by the extreme swelling and cracking of bamboo, a lower ultimate load-carrying capacity than that of the steel-reinforced components, and the requirement for employing asphalt emulsions. Based on the maximum stress values of 55 to 69 MPa for concrete beams with 3–4 % bamboo reinforcement, Glenn [4] suggested using bamboo tensile stresses of 34–41 MPa. It was suggested to utilize 3–4 % bamboo reinforcement to keep the beam deflection under  $l/360$  of the span.

A report was created in 1966 by Brink and Rush [5] to assist the field crew in designing and building BRC using an allowed stress technique, a method that is similar to that described in ACI 318 [6] for steel reinforced concrete. Based on a bond strength of 0.34 MPa and ultimate capacity of 124 MPa, they suggested a reasonable bamboo tensile stress of 28 MPa. For the serviceability criterion, a bamboo elastic modulus of 17.2 GPa was suggested.

Subsequently, a BRC flexural component was built as an unreinforced concrete component with a maximum tensile stress of  $0.67 \sqrt{f'_c}$  (compressive strength of concrete in MPa), according to the hybrid design technique proposed by Geymayer and Cox [7] in 1970. They found that with 3–4 % bamboo reinforcement, a total safety factor of 2–2.5 can be achieved. Numerous studies describing bamboo-reinforced flexural components have provided evidence supporting the design methods proposed by Geymayer and Cox [7]. Moreover, at optimum longitudinal bamboo reinforcement ratios of 3–5 %, a

concrete flexural member that would otherwise be unreinforced exhibited a capacity increase of at least 2.5 times.

In one of the early studies in India, Kurian and Kalam [8] investigated structural elements made of bamboo-reinforced soil-cement material. The main aim of that study was to identify a cost-effective alternative to rural housing in India. Soil-cement is a mixture of pulverized soil with small quantities (4–10 % by weight of soil and water) of Portland cement. This material was widely used for the construction of road bases and airports in mid-thirties. The study investigated bamboo-reinforced soil-cement foundations, building walls, and pavements. The bamboo was treated with a solution of 40 % rosin in alcohol and coated with white lead paint for waterproofing.

It was reported that soil cement exhibits a considerable increase in strength with age. Bamboo is not as effective as a compressive reinforcement because of its low compressive strength, which results from its fibrous nature. The results showed that the structural models were good at resisting flexure when made with the bamboo-reinforced soil-cement material. In addition, it was reported that reinforcing soil cement with bamboo imparts considerable rigidity to flexible pavements. Furthermore, it was found that when the plain soil-cement section was reinforced with bamboo without attempting to reduce the depth of the section, it worked well in the resisting moment. It was concluded that bamboo-reinforced soil cement has the potential to be used in rural construction, especially for building walls, foundations, and pavements.

Mansur and Aziz [9] conducted an experimental investigation into the viability of employing a woven bamboo mesh as a reinforcement for cement mortar. The addition of bamboo mesh increased the tensile, flexural, and impact strengths of the mortar, as well as its ductility and toughness. Studies have found that BRC beams are significantly better at handling loads than plain concrete beams in a four-point bending test with 2–3 % bamboo reinforcement [10].

### 3. Bamboo reinforcement in different structural members

Early research showed that BRC is an emerging field of research. However, further experimental work is required before arriving at any conclusion. Different experimental studies have been conducted on the use of bamboo as a reinforcing material in different structural members, some of which are discussed in the following section.

#### 3.1. Bamboo as reinforcement in slab

Kankam and Odum-Ewuakye [11] conducted experiments on 13 simply supported one-way slabs reinforced with *babadua* (*Thalia geniculata*) bars. Four-point loading was applied to the slabs. A schematic of the four-point loading is shown in Figure 2.

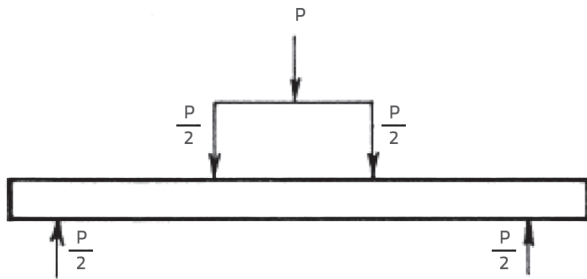

Figure 2. Schematic for four-point loading [11]

The results showed that the slabs collapsed owing to excessive slab deflection, flexural failure of babadua bars under tension, or concrete crushing. A short-term factor of safety was attained for span-to-effective depth ratios between 12.5 and 9.3 and shear span-to-effective depth ratios between 4.2 and 6.44. These slabs exhibited an extremely ductile behaviour and underwent significant deflection before failure. Kankam and Odum-Ewuakye [12] used babadua (*Thalia geniculata*) bamboo bars as reinforcements in two-way slabs supported on all four sides. A significant improvement in the flexural and punching shear strengths of the slabs was observed when tested under monotonic and cyclic loads. In addition, it was observed that the concrete slab with babudua bamboo reinforcement offered appropriate stiffness against deflection.

In 2005, Ghavami [13] investigated permanent-shutter concrete slab panels using *Dendrocalamus giganteus* bamboo. Half-sectioned bamboos, which functioned as permanent shutter forms, were filled with concrete, as shown in Figure 3.

A Sikadur 32-Gel was applied to the bamboo to prevent it from absorbing water from the concrete. The shear resistance of *Dendrocalamus giganteus* to full- and half-bamboo diaphragms was investigated. The half-bamboo had a shear strength of 10.89 MPa with a standard variation of 2.56 MPa.

Perera and Lewangamage [14] used strips of *Bambusa vulgaris* to reinforce a slab panel with dimensions 600 × 60 × 100 mm. They investigated the flexural behaviour of slab panels under a central uniformly distributed load. According to their findings, when bamboo and steel were combined, the slabs performed better than the control specimens with steel reinforcement and the specimens with bamboo reinforcement (bamboo alone).

Muda et al. [15] examined the effectiveness of BRC slab panels subjected to impact loads. The bamboo was tied to form a mesh at a spacing of 50 mm after being spliced and chopped

into the necessary diameters of 7.5 mm, 5 mm, and 2.5 mm. In this experiment, oil palm shells (OPS) in the concrete mix were used as an alternative to traditional aggregates, with an OPS-to-cement ratio of 0.45 and 0.6. They concluded that the bamboo diameter had a significant effect on the impact strength of the first crack, whereas the slab thickness had an even greater effect. In 2016, Muda et al. [16] examined the impact behaviour of 300 × 300 mm BRC that simply supported one-way slabs under impact loading. The bamboo-reinforcing material was prepared using *Buloh kuning* (*Bambusa vulgaris schrad*) bamboo. Rice husk was added to the concrete used to create the slab panels in proportions of 5 % and 10 % with respect to Ordinary Portland Cement complying to ASTM Type I [17]. During the experiment, the impact strengths of the slab panels were examined in relation to the bamboo diameter and slab thickness. It has been reported that, for both types of concrete mixes, the bamboo diameter and slab thickness have a linear relationship with the initial and ultimate crack strengths. The impact strength of these BRC slabs in comparison to that of typical reinforced cement concrete (RCC) slabs needs further investigation.

Chithambaram and Kumar [18] studied the flexural behaviour of slab panels made of ferro-cement and bamboo with fly ash used to partially replace cement. They used chicken-wire mesh and bamboo strips as reinforcements in one-way slabs. The results of partially replacing cement with fly ash and varying the slab thickness were explored. Twelve ferro-cement slab panels with dimensions of 470 × 940 mm and thicknesses of 40 and 50 mm, each containing six slabs, were tested as part of the experimental program. Six of these slabs were created using typical mortar at a ratio of 1:3, whereas six others were created using fly ash in place of 15 % of the cement. All slabs were cured for 28 days in wet gunny bags before testing under an evenly distributed weight. According to the test results, both slabs exhibited similar initial cracks and ultimate loads. In comparison to the experimental ultimate load capacity, the bamboo strips increased the estimated ultimate capacity of the slab at a rate that was approximately three times higher than that of the mortar and wire mesh.

Mali and Datta [19] investigated BRC slab panels using semicircular grooved bamboo strips (Figure 4) as reinforcements. They used a bond-tite epoxy adhesive to reduce the water absorption capacity of the bamboo strips from the surrounding concrete. Fifteen concrete slab panels with dimensions of 600 × 600 × 100 mm that comply with Eurocode EN-14488-5 (2006) [20] were cast and tested. The effects of completely replacing the primary steel reinforcement with bamboo were investigated

in terms of the failure modes, crack patterns, energy absorption capacity, and load-deformation characteristics.

By comparing plain cement concrete and reinforced cement concrete slab specimens, it was discovered that the concrete slab panels reinforced with grooved bamboo strips exhibited significantly higher load-bearing and



Figure 3. Bamboo reinforced permanent shutter shapes for concrete slabs [13]

deformation capacities. Additionally, the structural behaviour of the slab flexural performance was significantly improved, and it was only moderately inferior to that of RC slabs utilising mild steel bars as the main reinforcement.

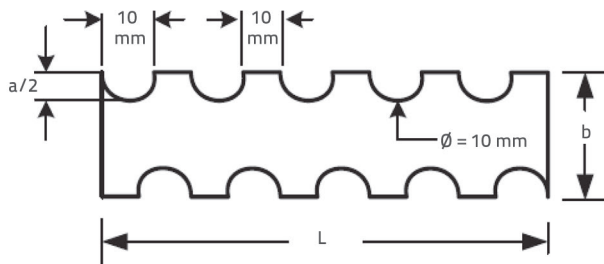

Figure 4. Semi-circular grooved bamboo strips [19]

Recently, Haryanto et al. [21] examined the structural behaviour of concrete footplate foundation slabs reinforced with bamboo under concentrated loading. Three distinct slab panels made of BRC and one panel made of steel-reinforced concrete (SRC), each  $600 \times 600 \times 70$  mm in size, were cast and examined. To establish the benefit of using bamboo instead of steel for reinforcement, the ultimate load, stiffness, load-deflection characteristics, cracking pattern, energy absorption capacity, and ductility of concrete slabs were measured. The uppermost part of a locally accessible string bamboo (*Gigantochloa apus*) with an average tensile strength of 138 MPa was used. The bamboo strips were carefully greased to reduce their water-absorption capacity. The mix design and sample testing were performed according to the SNI 1974:2011 (BSN 2011) criteria. The volume of the coarse aggregate was divided into two different nominal sizes to ensure appropriate interlocking between the bamboo and concrete. This consisted of aggregates with a 70:30 ratio in the 20 mm and 10 mm sizes. According to the findings, BRC slabs can achieve a strength of 82 % compared with steel-reinforced concrete slabs. Furthermore, ductility verified by the two types of samples was nearly comparable (up to 93 %). The authors claimed that the structural performances of the slabs reinforced with bamboo and steel were similar.

From the above discussion, it was concluded that the slab panels reinforced with bamboo strips performed almost as well as those reinforced with steel. When used as reinforcement, grooved bamboo strips provide greater strength than plain bamboo strips. In addition, bamboo treatment is required to reduce its water absorption capacity and increase its durability.

### 3.2. Bamboo as reinforcement in beam

Beam members are one of the most important components of a building structure. They carry both horizontal and vertical loads. Traditionally, steel has been used as a reinforcement in beams to increase their load-carrying capacities. Research has been conducted to improve the mechanical quality of plain concrete by substituting naturally occurring elements instead of steel.

BRC beams with dimensions of  $140 \times 150 \times 1100$  mm were tested to understand their flexural behaviour. In a four-point bending test (Figure 5), Mali and Datta [22] investigated the flexure behaviour of BRC beams.

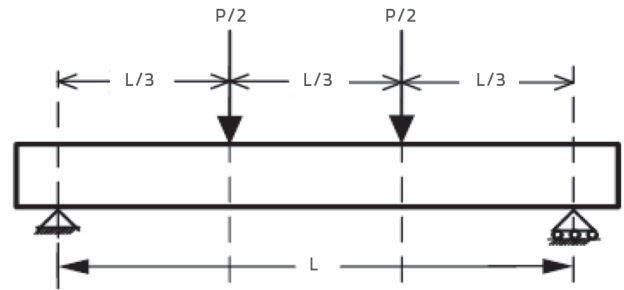

Figure 5. Diagram showing the four-point bending test [22]

Experimental investigations were conducted on three distinct types of concrete beams, namely beams with traditional steel reinforcement, beams with bamboo reinforcement, and plain concrete beams (without reinforcement). The energy absorption capacity, ultimate load, flexural strength, shear strength, and linear stiffness of these beams were analysed to better understand their flexural behaviours. Two types of BRC beams with longitudinal and shear reinforcements (stirrups) made of bamboo strips were examined. Using 2.8 % and 3.8 % longitudinal bamboo reinforcements in proportion to the beam cross section, BRC beams were cast and analysed.

It was discovered that plain cement concrete (PCC) beams were significantly outperformed by both forms of BRC beams in terms of ultimate load, first crack load, ductility, and energy absorption capacity. Additionally, it was found that the flexural strength of the BRC beam with 3.8 % bamboo reinforcement was comparable to that of the RCC (reinforced cement concrete) beam with 1.23 % steel reinforcement.

Kankam and Odum-Ewuakye [23] investigated the flexural strength and behaviour of Babadua (*Thalia geniculata*)-reinforced concrete beams of sizes  $100 \times 180 \times 1500$  mm and  $135 \times 235 \times 1800$  mm with different percentages of tensile reinforcement from 2.87 to 12.13. Stirrups were formed from Babadua strips that were approximately 8 mm thick. The beams were tested for failure under four-point and cyclic loading conditions, as shown in Figure 6.

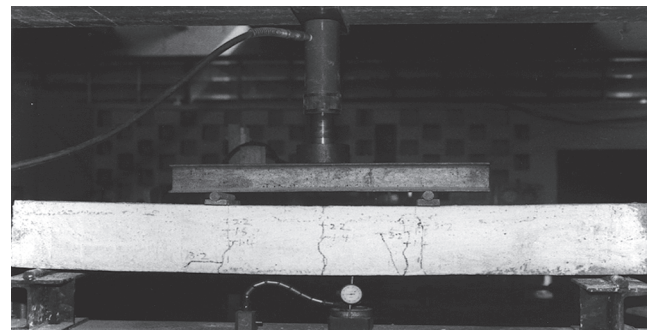

Figure 6. Experimental setup for four-point loading [23]

Table 1. Recent studies on BRC beam

Author	Bamboo species	Bamboo treatment	Size of beam	Test results
Anto et al. (2023) [25]	Dendrocalamus Strictus	Untreated	140 x 150 x 1100 mm	Provided strength comparable with steel reinforced beam
Al-Fasih et al. (2022) [26]	Bambusa Heterostachya (BH), Schizostachyum Brachycladum (SB) i Bambusa vulgaris Vittata (BV)	Untreated	150 x 150 x 1000 mm	Bamboo species BV and BH can replace steel reinforcement
Budi and Rahmadi (2019) [27]	Dendrocalamus Asper	Untreated	110 x 150 x 1700 mm	Strips with U-shape grooves improves the flexural capacity of beams
Awoyera et al. (2019) [28]	Locally available bamboo	Bituminous adhesive	150 x 150 x 2000 mm	flexural strength increases with increase in curing age

The results showed that the collapse of the beams was either due to flexural failure caused by concrete crushing or diagonal tension failure of the concrete in the shear span. They also conducted tests on the performance of beams aged for more than one year after casting. The flexural strength of the Babadua-reinforced beams was unaffected, and there was no indication that the reinforcing bars had deteriorated.

For rural buildings, Mark and Russell [24] conducted a comparative study of BRC beams using various stirrup materials. They used strips of *Bambusa vulgaris* for longitudinal tension reinforcement, and bamboo, rattan cane and steel for stirrups. Four-point bending tests were performed on the beams until they failed. Using the performance model developed in this study, the least expensive and most cost-effective method for providing shear reinforcement to bamboo-reinforced beams was investigated. Steel stirrups were shown to be the most cost-effective option based on the beam performance index (BPI), which measures the amount of energy absorbed per unit cost of a beam.

Apart from the abovementioned literature, many more studies have been conducted on BRC beams; some recent studies are listed in Table 1.

From the above discussion, it was concluded that the flexural capacity of the beam increased when it was reinforced with bamboo strips. 3.8% of bamboo reinforcement was comparable with that of 1.23% of steel reinforcement with respect to beam cross-section. In addition, bamboo-reinforced beams performed better when steel stirrups were used.

### 3.3. Bamboo as reinforcement in column

A column is a structural member which transfers the compressive load of a superstructure to that of a substructure. Leelatanon et al. [29] examined the ductility and compressive strength of short concrete columns (125 x 125 x 600 mm) with both longitudinal

and shear reinforcements (stirrups) made of bamboo tested under concentric loading. The bamboo strips were treated with a water-repellent substance (Sikadur-31 CFN). Compared with untreated strips used in columns, this treatment increased the strength and ductility of columns reinforced with treated strips. Furthermore, 3.2% treated bamboo reinforcement could replace 1.6% steel reinforcement in a column with equivalent behaviour, strength, and ductility.

To repair and strengthen treated bamboo-reinforced square concrete columns with dimensions of 150 x 150 x 600 mm, Akinyemi and Omoniyi [30] examined the use of an acrylic polymer as a concrete matrix modifier and ferrocement jacket confinement. Thirty columns were cast, of which 10 were made of concrete using both conventional and modified concrete, and were tested for failure. Ten more concrete columns from each concrete design mix were preloaded at 75%, 50%, and 25% of the ultimate load, repaired with ferro-cement jacket, and subsequently placed through an axial test. The last 10 concrete columns were ferro-cement jacketed before axial testing. The tests involved measuring axial and lateral deflections.

It was found that the column with the addition of cement and polymer exhibited a 60% increase in average ultimate load when compared to the control column. The columns that had been repaired with ferro-cement material had the lowest lateral and axial deflections, which were 93% and 72%, respectively. The failure patterns of the concrete columns were characterised by mortar bulging and peeling. The strength of the restored columns made of ferro-cement jackets and acrylic polymer was nearly as high as that of the unrepaired columns.

Axial compression and transverse loading experiments were performed by Agarwal et al. [31] on unreinforced, steel-reinforced, and bamboo-reinforced columns to determine their lateral deflection, load-carrying capability, and failure mode patterns. Bamboo culms of Muli Bamboo (*Melocanna bambusoides*) with a brownish appearance were acquired at 3–4 years of age. Its

modulus of elasticity was 24.46 GPa, and its average tensile strength was 185.93 MPa. Different chemical adhesives, namely tapcrete P- 151, Anti Corr RC, Araldite, and Sikadur 32 gel, were applied to bamboo to examine their impact on the bond strength at the bamboo-concrete composite interface.

The M20 grade concrete was used to cast 24 columns with dimensions of 150 × 150 × 1000 mm. Three columns were cast: one plain, one with 0.89 % steel reinforcement, one with untreated bamboo (with reinforcements of 8 %, 5 %, and 3 %), and one with treated BRC (with reinforcements of 8 %, 5 %, and 3 %).

From the above results, it can be concluded that the Sikadur 32 gel had the strongest average binding between the bamboo and concrete. The treated bamboo reinforced column with 8 % reinforcement could support a load that was comparable to that carried by steel reinforced column. Owing to the poor bonding between bamboo and concrete, the untreated bamboo-reinforced columns withstood significantly less load than the treated bamboo-reinforced columns.

### 3.4. Bamboo as reinforcement in walls

Walls are among the most important components of building structures. They normally occupy the majority of a building space and require numerous construction materials. Bricks are typically used in walls to increase the dead load of a building. However, bricks significantly increase the price of walls and degrade the ground by consuming fertile soil.

Puri et al. [32] studied prefabricated wall panels with bamboo reinforcement, which are useful for affordable housing. Wall panels, which were 2440 mm long, 300 mm wide and 50 mm thick, were created. Bamboo strips of 3–5 mm thickness of the *Bambusa balcoa* species were used as reinforcements in the wall panels. Each box had a crisscross pattern and had dimensions of approximately 50 × 50 mm. Because bamboo contains cellulose, lime water treatment was employed to stop the degeneration of bamboo resulting from termite attack and fungus formation. To reduce the water absorption capacity of bamboo, Sikadur 32 LP epoxy, an alternative to Sikadur 32 gel, was used. A mortar mix with a cement to sand ratio of 1:2 (cement and sand) was used to cast the wall panels. The rebound hammer and transverse loading tests were conducted on the panels.

It was reported that compared with standard brick walls, the proposed wall panel system was significantly more affordable, energy-efficient, and lightweight. Compared with a brick-wall system, it lowered the dead weight of walls by 56 % and the price by 40 %.

Ganesan et al. [33] studied the strength and behaviour of wall panels made of BRC under two-way in-plane action. Splints of *Bambusa bambos*, 20 mm wide and varying in thickness from 8–15 mm, were used as reinforcement. A varnish coating was applied to the splints to make them water resistant. Sandblasting of the splints was performed to obtain a better bond with the concrete. Three prototypes of BRC wall panels, with aspect ratios of 1.667, 1.818, and 2 and thickness ratios

of 12.5, 13.75, and 15, were considered. All the samples had a consistent slenderness ratio of 25. A uniformly distributed in-plane load applied at an eccentricity of  $t/6$  was used to examine the failure of wall panels with varied aspect and thickness ratios. It was reported that owing to the two-way action of the wall panels, biaxial bending occurs in the planes parallel and perpendicular to the axis of loading, causing diagonal cracks to form that extend from the corners of the wall to the centre of the wall panel. With increasing aspect ratio, the wall panel deflection increased. According to the mentioned study, wall panels made of BRC with aspect ratios ranging from 1.667–2 and thickness ratios ranging from 12.5–15 could withstand weights of up to 630 kN.

From the above discussion, it can be concluded that bamboo-reinforced wall systems are more affordable and lightweight than traditional wall systems. They have higher load-carrying capacities than traditional brick walls. Treatment should be performed to avoid deterioration of the bamboo strips. Overall, they are good replacements for the traditional brick walls.

## 4. Performance of bamboo-reinforced structures under dynamic loading

BRC is a popular composite material owing to its strength, durability, and low cost. The dynamic loading effect on bamboo-reinforced elements is an important factor to consider when designing structures that are subjected to seismic activity. One of the limitations of BRC is its limited ductility, which is a concern in seismic areas where structures must sustain through large deformations during earthquakes without collapsing. Few studies have been conducted on the dynamic-loading effects of BRC elements.

To understand the seismic behaviour of houses built using bamboo as reinforcement, in 2006, Kaushik et al. [34] reviewed the performance of structures during the Sikkim earthquake that occurred on 14<sup>th</sup> February 2006. This earthquake was of moderate level with a magnitude of 5.7 on the Richter scale. Heritage structures, masonry structures, and reinforced concrete buildings performed poorly during the earthquake, whereas traditionally constructed wooden/bamboo houses sustained tremendously well. One such traditional housing system commonly used in Sikkim is the 'Ikra' housing system, as shown in Figure 7.



Figure 7. Typical Ikra housing [34]

'Ikra' houses are one-story buildings with masonry walls made of brick or stone that extend up to roughly one metre above the plinth. This brickwork supports plastered walls made of bamboo braided into wooden frames. GI roofing sheets supported on bamboo trusses are typically used.

It was found that there was no significant damage to the Ikra housing structures during the earthquake, thus concluding that traditionally constructed bamboo-structured housing systems performed well during earthquakes.

González and Gutiérrez [35] investigated the performance of bamboo Bahareque walls under cyclic loading conditions. The Bahareque walls contain cement plaster on both sides of a timber frame with split bamboo at the centre. The primary goal of the study was to perform an experimental evaluation of the rigidity and deformation properties of prefabricated 'bamboo bahareque' shear walls developed in Costa Rica by the Bamboo Foundation (FUNBAMBU) under horizontal cyclic loads simulating earthquake effects. Seven wall panels, with length 2.7 m, height 2.4 m, and thickness varying from 40 to 60 mm, were experimentally investigated. The findings demonstrated that the tested 'bamboo bahareque' walls have sufficient strength to sustain loads caused by earthquakes of a sizeable magnitude. During cyclic loading, they exhibited ductile behaviour. Bamboo has a high strength-to-weight ratio, indicating that it can withstand heavy loads without becoming too heavy. Additionally, bamboo has a high damping capacity that allows it to absorb and dissipate energy in the form of heat. These properties make bamboo an ideal material for earthquake-resistant structures.

Moroz et al. [36] investigated the performance of BRC masonry shear walls. Two different types of walls were constructed: one reinforced with conventional steel reinforcement, and the other with Tonkin cane bamboo reinforcement, both vertically and horizontally, in bond beams. It has been reported that walls reinforced with bamboo exhibit enhanced shear capacity and ductility compared with unreinforced concrete block masonry. In addition, it was observed that the bamboo-reinforced shear walls showed remarkably similar behaviour to those reinforced with steel. However, special care must be taken to prevent moisture absorption by bamboo in a cementitious matrix.

In terms of dynamic loading effects, BRC has been found to have good resistance to fatigue and impact loading. However, further research is required to fully understand the dynamic properties of BRC and its behaviour under different types of loading.

Overall, the use of BRC in seismic-resistant structures is an exciting area of research with the potential to revolutionise the construction industry.

## 5. Different codes for bamboo

For decades, several studies have been conducted by different researchers to investigate the potential of bamboo as a reinforcement material for structural members. These studies have helped develop codes for bamboo so that one can easily

understand its behaviour. IS 8242:1976 [37] provides different methods for testing split bamboos. This standard was used to assess the physical and mechanical characteristics of split bamboo, such as moisture content, specific gravity, static bending, compression perpendicular to the grain, and shear perpendicular to the grain. Similarly, IS 6874:2008 [38] specifies different test methods for determining the physical and mechanical properties of round bamboo. This standard also contains methods for determining the density, shrinkage, and tensile strength parallel to the grains of round bamboo samples.

The preservation of bamboo is important when it is used for structural purposes. IS 9096:2006 [39] provides preservatives and treatment procedures for bamboos used for structural purposes such as scaffolding, house building, walls, trusses, and posts. Additionally, it offers suggestions for the best course of action based on numerous applications of bamboo. Coal tar creosote, copper zinc-naphthate, copper chrome-arsenic composition, copper chrome-boron composition, acid-curpic-chromate composition, and boric acid-borax are some of the chemicals recommended for bamboo treatment. IS 15912:2018 (Structural Design Using Bamboo – Code of Practice) [40] is an important code for the structural design of concrete members reinforced with bamboo. Concerning mechanical resistance, structural resistance, and structural endurance, this standard outlines board design concepts for using structural bamboo in buildings. This standard covers the design of bamboo-based panels that are mechanically or adhesively joined, including round, split, and glue-laminated bamboos. It also includes conventional bamboo joints for quality control, minimum strength data, grading criteria, and dimensional stability. Constructional factors that use bamboo, such as on-site work, off-site component manufacturing, and on-site assembly, are also included.

According to this code, India accommodates more than 100 different varieties of bamboo, some of which are solid, but most have hollow structures. Twenty bamboo species were systematically tested, and 16 species were recommended for structural purposes. Some of the physical and mechanical properties of the species are listed in Table 2.

Fully grown bamboo of at least four years of age should be used for structural purposes. Bamboos that are solid or whose walls are comparably thicker and typically have nodes at frequent intervals are considered beneficial for structural purposes. Shattered, broken, or collapsed bamboo should be discarded. Dead or immature bamboo, boreholes, rot, collapses, and checks deeper than 3 mm should also be avoided. The use of green bamboo poles in buildings is not recommended. Joints and terminals may loosen after only a few weeks because green bamboo is prone to shrinkage. Furthermore, insects and microorganisms prefer green bamboo over dried bamboo.

The natural durability of bamboo is poor and varies from 12 to 36 months, depending on the species and weather. When utilised outdoors and in contact with the Earth, bamboo



Table 2. Physical and mechanical properties of bamboos [40]

Species		In air dry condition				In green condition			
Properties		Maximum compressive strength [N/mm <sup>2</sup> ]	Modulus elasticity x 10 <sup>3</sup> [N/mm <sup>2</sup> ]	Modulus of rupture [N/mm <sup>2</sup> ]	Density [kg/m <sup>3</sup> ]	Maximum compressive strength [N/mm <sup>2</sup> ]	Modul elastičnosti x 10 <sup>3</sup> [N/mm <sup>2</sup> ]	Modulus of rupture [N/mm <sup>2</sup> ]	Density [kg/m <sup>3</sup> ]
<b>Group A</b>									
1	Bambusa glancescens (Syn. B. nana)	-	-	-	-	53.9	14.77	82.8	691
2	Dendrocalamus strictus	69.1	15	119.1	728	35.9	11.98	73.4	631
3	Oxytenanthera abyssinica	-	-	-	-	46.6	14.96	83.6	688
<b>Group B</b>									
1	Bambusa balcooa	60.6	-	-	-	46.7	7.31	65.4	783
2	B. pallida	-	-	-	-	54	12.9	55.2	731
3	B. nutans	47.9	10.72	52.4	673	45.6	6.62	52.9	603
4	B. tulda	68	10.07	66.7	722	40.7	7.98	51.1	658
5	B. auriculata	54.3	21.41	89.1	670	36.7	15.01	65.1	594
6	B. burmanica	65.2	17.81	105	672	39.9	11.01	59.7	570
7	Cephalostachyum pergracile	49.4	19.22	71.3	640	36.7	11.16	52.6	601
8	Melocanna baccifera (Syn. M. bambusoides)	69.9	12.93	57.6	751	53.8	11.39	53.2	817
9	Thyrsotachys oliveri	58	12.15	90	758	46.9	9.72	61.9	733
<b>Group C</b>									
1	Bambusa arundinacea (Syn. B. bambos)	53.4	8.96	80.1	663	35.3	5.95	58.3	559
2	B. ventricosa	-	-	-	-	36.1	3.38	34.1	626
3	B. vulgaris	-	-	-	-	38.6	2.87	41.5	626
4	Dendrocalamus longispathus	61.1	6.06	47.8	684	42.1	5.51	33.1	711

typically decomposes after one or two years. However, bamboo has a service life of two to five years when used in concealed, off-the-ground environment. As fungal deterioration in the sclerenchymatous fibres (Figure 8) begins, the mechanical strength of the bamboo rapidly deteriorates. The correct preservation treatment must be applied to bamboo to increase its durability.

IS 15912:2018 [40] prescribes fire safety for bamboo structures. This indicates that, with the help of chemical treatments, bamboo can become fire-resistant. IS 15912:2018 [40] also mentioned that bamboo has a high tensile strength owing to its fibrous nature. In accordance with the restrictions on design and construction, it can serve as a substitute material for reinforcement in concrete. The ultimate tensile strengths of some bamboo species under direct tension are almost identical to those of steel, ranging from 1400 to 2000 kg/cm<sup>2</sup>. Design guidelines for concrete structures with steel have also been applied to concrete members made of bamboo.

International standards are available to guide designers and researchers. Information on the use of bamboo structures, including those constructed of round bamboo, split bamboo, glued laminated bamboo, and panels made of bamboo fastened together using adhesives or mechanical fasteners, is provided by ISO 22156 – 2004 [42]. It is based on the performance of the structure and the limit state of the design. It only addresses the demands for serviceability, durability, and mechanical resistance of structures.

ISO 22157 – 1:2004 [43] outlines the test procedures for assessing the strength and physical characteristics of bamboo, including moisture content, mass per volume, shrinkage, compression, bending, and tension. It also involves tests on bamboo samples conducted to acquire data that may be utilised to define distinctive strength functions and establish permitted stresses. This information can be used to establish a relationship between the mechanical characteristics and elements such as moisture content, mass per volume, growth site, location along the clum, and the presence of nodes and internodes for quality control purposes.

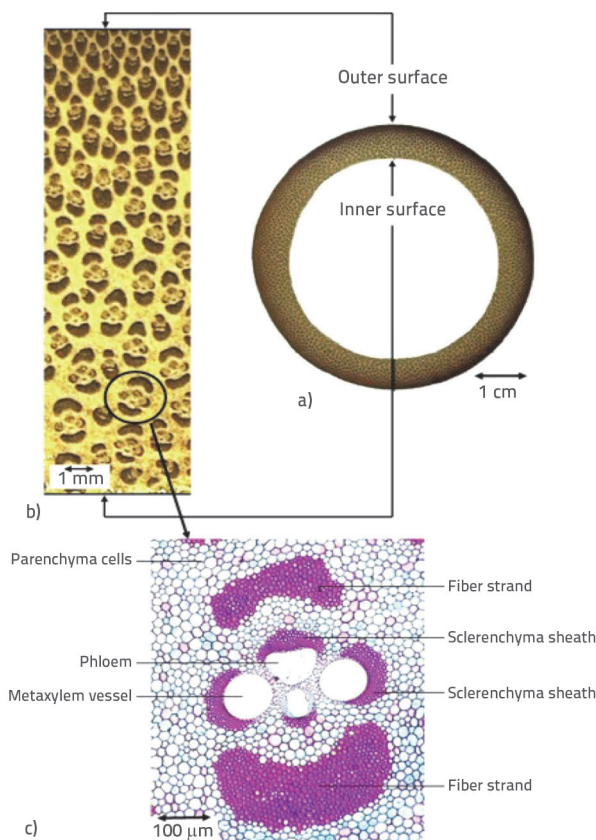

Figure 8. Diagram of inner cross-section of bamboo [41]

There are several bamboo species available worldwide. Therefore, grading bamboo is an important procedure for determining its suitability for structural applications. To grade round or pole bamboos for structural purposes, ISO 19624:2018 [44] outlines specific mechanical and visual grading procedures. Visual sorting is performed based on the observable features of the specimen. Mechanical sorting involves a non-destructive assessment of qualities that are known to correlate with the characteristic values defining a grade.

### 6. Bamboo concrete bond

The bond formed between the concrete and reinforcing bars enables strain compatibility by ensuring that the stresses from the reinforcing material are adequately transmitted to the concrete. This guarantees that there is no slippage between the reinforcement bar and surrounding concrete, which is necessary for their composite behaviour. The fracture control patterns, section stiffness, and anchoring of the reinforcing bars were influenced by the bond development mechanism.

The bond behaviour in reinforced concrete is affected by numerous factors, including the cover of concrete, spacing between

reinforcing bars, size of reinforcing bars, transverse reinforcement, properties of concrete and steel, surface state of reinforcing bars, casting position, development, and length of splice [45]. In addition, the anchorage length of the reinforcing bars was determined by the increase in the bond strength between the steel and concrete. The lack of a proper anchorage length contributes to a variety of failures, particularly in lap splices, cantilever supports, and beam-column joints in conventional structural designs. This emphasises the importance of the anchoring length, as it depends on the adequate bond strength. When the end anchorages are reliable, sufficient bonds are available for the beam to carry the imposed load even if local bonds are unavailable in other areas of the beam [46].

The behaviour of BRC members is significantly affected by the bonding phenomenon between bamboo and concrete, particularly the post-cracking behaviour [47]. The importance of the bond between the bamboo and concrete was first emphasised by Mansur and Aziz [9] in 1983. They claimed that adding bamboo mesh considerably increased the ductility, toughness, and tensile, flexural, and impact strengths of the mortar. However, despite these improvements, particularly in terms of tension, significant cracking was observed owing to the weak bond between the bamboo and concrete. The binding strength between bamboo and concrete is significantly affected by dimensional variations in bamboo caused by changes in moisture and temperature. The swelling and shrinking of bamboo reinforcement during the casting and curing of concrete is a major issue [13], as shown in Figure 9.

When concrete experiences hydration during curing, bamboo splints captivate and store moisture. Consequently, the bamboo expanded, and the concrete began to crack, as shown in Figure 8(b). Furthermore, the hydration of the concrete persists, and during the post-curing period, the concrete absorbs the water stored in the bamboo, causing the bamboo to contract. Although the cracks started to decrease, the presence of voids weakened the bond between the bamboo and concrete, as shown in Figure 8(c). The correct bond between bamboo and concrete cannot be created because of the ongoing process of bamboo swelling and shrinking, which severely restricts the use of bamboo as a reinforcement material instead of steel [13]. The binding strength is affected by three main factors: swelling and shrinkage of the bamboo.

- adhesion-promoting qualities of cement
- developing frictional stresses on the surface of the bamboo strips
- the shear resistance of concrete because of the surface configuration and roughness of the reinforcing strip [10].

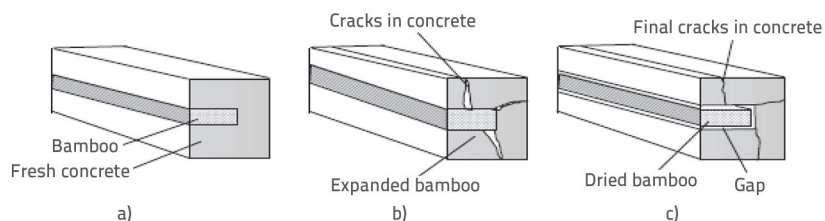

Figure 9. Performance of bamboo used in concrete during curing: a) bamboo in concrete; b) bamboo at the time of curing of concrete (cracks developed); c) visible voids and cracks in concrete after curing [48]

According to Mali and Datta [49], increasing bond strength can improve the uniaxial and flexural responses of BRC beams. They suggested that by using the right surface treatments, the swelling and shrinkage of bamboo in concrete could be minimised. Researchers have used different chemicals to reduce the water absorption capacity of bamboo splints. Table 3 lists the different chemical treatments applied to the bamboo.

**Table 3. Chemical treatments**

Researcher	Year	Chemical treatments
Fang and Mehta [50]	1978	Sulphur
Ghavami [10]	1995	Negrolin
Ghavami [13]	2005	Negrolin
		Negrolin with sand
		Negrolin with wire and sand
		Sikadur 32 Gel
Terai and Minami [51]	2012	Synthetic Resin
		Synthetic Rubber
Sakaray et al. [52]	2012	Water-proof coating
Kute and Wakchure [53]	2013	Black Japan (Bituminous Paint)
		Black Japan with zeolite powder
Agarwal et al. [31]	2014	Araldite
		Araldite with Wire
		Tapcrete P 151
		Anti Corr RC
		Sikadur 32 gel
Javadian et al. [54]	2016	Epoxy coating (water based)
		Epoxy coating (water-based) and fine sand
		Epoxy coating (water-based) and coarse sand
		True Grip EP and BP
		Coarse sand with True Grip EP and BP
		Exaphen
		Coarse sand with Exaphen
		Enamel
Nindyawati and Umniati [55]	2016	Sand-dusted waterproofing paint
Puri et al. [32]	2017	Sikadur 32 LP epoxy
Dey et al. [56]	2018	Sand rolled bamboo with epoxy
		Coir rolled bamboo with epoxy
		G.I. rolled bamboo with epoxy
Mali and Datta [49]	2019	Bond Tite chemical adhesive
		Triflor PAUL Lacquer coating
		Araldite
		Streproxy
		Bitumen (VG-30)
		EPI Bond - 21

In 1995, Ghavami [10] conducted a preliminary evaluation of bamboo reinforcement with various coatings. In addition, in 2000, Janssen [57] noted that treating bamboo before its use as a reinforcement would significantly extend its life. Kute and Wakchare [53] used bitumen-based black Japan paint to reduce the water-absorption capacity of bamboo. They discovered that black Japan inhibited water absorption by 75 %, whereas only 10 % of the bond stress was affected.

Researchers have conducted pull-out tests after treating bamboo with various chemicals to determine the binding strength between bamboo and concrete. Pull-out tests in line with IS 2770 (Part 1) [58] are commonly used to evaluate the bond strength growth between steel bars and concrete. Pull-out tests are primarily used to assess the interfacial strength between concrete and reinforcing bars. A typical pull-out test setup is shown in Figure 10.

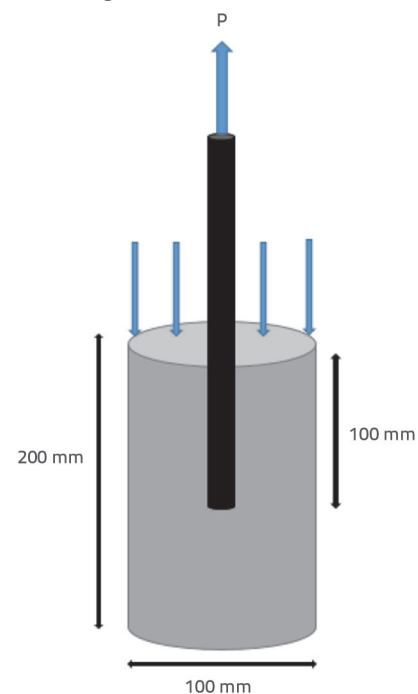

**Figure 10. Pull-out test setup**

Table 4 provides a thorough analysis of the bond strengths obtained by various chemical treatments. From table 4, it was concluded that, compared with lightweight BRC beams made of plain cement concrete, treating bamboo with negrolin-sand-wire boosts the bond strength by 90 % and the load-carrying capability by 400 % [10]. The bond strength of bamboo treated with Sikadur 32 gel, in comparison to bamboo treated with negrolin-sand-wire, has been found to be improved (2.75 MPa) [13]. According to Maity et al. [48], the binding between bamboo and concrete is strengthened when bamboo mats coated with asphalt and sand are sprayed to produce a BRC wall. Additionally, a variety of epoxy agents, including Tapcrete P-151, Sikadur 32 gel, Araldite, and Anti Corr RC, have been used to treat bamboo surfaces. It was discovered that Sikadur 32 gel-treated bamboo

**Table 4. Bond strength achieved with chemical treatments**

Year	Researcher	Chemical treatments/coatings	Bond strength [MPa]
1995	Ghavami [10]	No treatment	0.52
		Negrolin with sand	0.73
		Negrolin with wire and sand	0.97
2005	Ghavami [13]	No treatment	0.52
		Negrolin with sand	0.73
		Negrolin with wire and sand	0.97
		Sikadur 32 Gel	2.75
2012	Terai and Minami [51]	Synthetic resin spread with brush	1.34
		Synthetic resin spread using spray	1.25
		Synthetic rubber spread using spray	1.18
		Deformed Bars	2.43
2012	Sakaray et al. [52]	Water-proof coating (150 mm embedment length)	1.45 - 1.95
		Water-proof coating (200 mm embedment length)	1.07 - 1.25
		Water-proof coating (260 mm embedment length)	0.95 - 1.05
2013	Kute and Wakchaure [53]	Black Japan (Bituminous Paint)	0.66
		Black Japan with zeolite powder	1.06
2014	Agarwal et al. [31]	Plain Bamboo	0.127
		Araldite	0.232
		Araldite with Wire	0.539
		Tapcrete P 151	0.315
		Anti Corr RC	0.159
		Sikadur 32 Gel	0.588
2016	Javadian et al. [54]	No Coating	3.61
		Epoxy coating (water based)	3.47
		Epoxy coating (water based) and fine sand	3.65
		Epoxy coating (water based) and coarse sand	3.61
		True Grip EP	3.3
		Coarse sand and True Grip EP	3.45
		True Grip BP	2.42
		Coarse sand and True Grip BP	2.62
		Exaphen	3.36
		Coarse sand and Exaphen	3.46
		Enamel	3.4
2016	Nindyawati and Umniati [55]	Sand-dusted waterproofing paint	0.41

Table 4. Bond strength achieved with chemical treatments

Year	Researcher	Chemical treatments/coatings	Bond strength [MPa]
2016	Mulyati and Arman [59]	Petung bamboo	0.62
		Petung bamboo (Square) with varnish	2.22
		Petung bamboo (Square) with winding wire	1.9
		Petung bamboo (Round) with varnish	1.7
		Petung bamboo (Round) with winding wire	1.49
		Wulung bamboo	0.62
		Wulung bamboo (Square) with varnish	1.33
		Wulung bamboo (Square) with winding wire	0.95
		Wulung bamboo (Round) with varnish	1.12
		Wulung bamboo (Round) with winding wire	0.98
2018	Dey and Chetia [56]	Sand Rolled bamboo with epoxy	5.96
		Coir Rolled bamboo with epoxy	8.46
		G.I. Rolled bamboo epoxy	9.71
2019	Mali and Datta [49]	Triflor PAUL Lacquer coating	1.04
		Bond Tite chemical adhesive	2.35
		Araldite	1.44
		Streproxy	1.88
		Bitumen (VG-30)	0.97
		EPI Bond - 21	1.54

had the strongest bond with the bamboo treated with an epoxy agent [31]. The bond strength between bamboo and concrete was studied in 2016 by Javadian et al. [54] using water-based epoxy coatings, TrueGrip EP, TrueGrip BP, and Exaphen coating. The coatings were applied with or without sand. They discovered that the addition of sand increased the bonding between the bamboo and concrete owing to an increase in the surface friction between the concrete and sand particles. By using epoxy on the bamboo surface with sand coating, the bond strength can be increased to 3.65 MPa.

Terai and Minami [51] conducted pull-out tests on bamboo using various synthetic resins and rubber surface treatments. It was discovered that the bond stress increased from 0.60 MPa to 1.34 MPa following the treatment.

Sakaray et al. [52] conducted a pull-out test in 2012; however, they used rounded bamboo culms. The average bond stress decreased as the embedment length increased. Furthermore, they observed that the decrease in the bond stress was more pronounced in the case of steel bars. Because bamboo is anisotropic and has transverse material properties as well as higher shear lag impacts, these reductions are necessary [52]. Mulyati and Arman [59] tested Petung and Wulung bamboo by applying varnish and winding wires, and the bond strengths of both bamboos were examined. They found that the maximum

bond strength of Petung bamboo after treatment with varnish was 2.22 MPa. The bond strength achieved was 0.41 MPa when Apus bamboo coated with waterproofing paint and sprinkled with sand was tested [55]. Dey and Chetia [56] conducted a comparative study of three types of bamboo strips with frictional resistance properties owing to the treatment of the strips with Coir, G.I. and Sand. All strips were coated with epoxy. The highest bond stress, 9.71 MPa, was found in G.I. rolled bamboo rebar, which was found to be higher than the bond stresses of 5.96 MPa and 8.46 MPa for sand rolled and Coir rolled bamboo rebar, respectively. Along with chemical treatment, geometrical and mechanical adjustments also seem to hold promise for increasing the binding qualities. For instance, the bond strength was increased to 4 MPa using mechanical procedures including notching, nailing, wrapping wires, hose clamps, corrugating bamboo, and other similar methods [60]. A bamboo specimen with nodes had a 15 %–22 % stronger binding for all types of chemical treatments [53].

## 7. Durability of BRC

Durability plays a very important role when natural fibres are used as construction materials for understanding their long-term behaviour. Although bamboo has been shown to exhibit good

short-term performance in concrete structures, it is important to understand its long-term performance. A potential concern regarding the use of bamboo in concrete is its susceptibility to decay and insect damage. Several studies have shown that proper treatment and protection can significantly reduce these risks [61]. For example, bamboo can be treated with boron to render it resistant to insects and decay. Additionally, the durability of bamboo varies from species to species.

Another important factor to consider is the durability of the concrete. Over time, concrete can be subjected to various forms of deterioration such as cracking, spalling, and corrosion of steel reinforcements. These processes can weaken the structure and reduce the long-term performance.

Lima et al. [63] analysed the durability of bamboo used as reinforcement in concrete. In total, 500 *Dendrocalamus giganteus* bamboo specimens were used in this study. The inner cross section of the bamboo was also studied to understand the behaviour of the bamboo fibres. The uppermost layer of bamboo, known as the barker, is composed of epidermal cells that include a waxy layer known as cutin. Bamboo culms are composed of a composite material, and diaphragms or nodes divide them into segments. The innermost layer was composed of *sclerenchyma* cells. A tissue-like matrix known as *parenchyma* is wrapped around the fibres, veins, and sap conductors that make up the middle layer and are randomly arranged in the transverse section. Parenchyma makes up, on average, 30% of the culms, followed by fibres at 60%, and sap conduction at 10%. The physical and mechanical characteristics of bamboo, which vary among species, are directly affected by these percentages. The majority of the bamboo fibres were found to be entirely enclosed within the parenchyma and were not directly exposed to the alkalinity of the cementitious matrix.

The durability was assessed by altering the tensile strength and Young's modulus of the bamboo. The specimens were then subjected to a setup that includes soaking and drying cycles. Each sample was soaked and then dried for 24 h. The samples with concrete were placed in tap water, whereas those without concrete were immersed in calcium hydroxide solution. The Young's modulus and tensile strength were assessed after 7, 15, 30, 45, and 60 cycles. There was no considerable change in the mechanical properties of the bamboo.

According to Moh and Khatib [61], the resistance of bamboo to fungi can be increased by protective finishes and coatings that prevent it from wetting. Heat treatment is another method of treating biological degradation. Heat treatment increases the resistance of bamboo to fungi and insects.

Recently, Awolusi et al. [63] studied the flexural and durability of BRC prisms. They investigated the resilience of BRC under challenging working conditions, including hot, acidic, and saline environments. Rectangular prisms of BRC and steel-reinforced concrete with dimensions of 150 × 150 × 550 mm with M 25 grade concrete were used for the study. Following a 60-day curing period, during which the BRC samples were subjected to unfavourable working conditions, the flexural strength and weight loss of the concretes were evaluated. It was found that, in comparison to the steel-reinforced concrete samples, the BRC samples showed a

reduced slope of strength loss in the high-temperature tests, with a strength loss of 0.407 N/mm<sup>2</sup> for the BRC and 5.5 N/mm<sup>2</sup> for the steel-reinforced concrete. The acid and chloride attack tests indicated slower weight and strength losses for the BRC samples. The weight loss for steel reinforced concrete and BRC beams was 0.95 kg and 0.54 kg for acid attack and 0.893 kg and 0.087 kg for chloride attack, respectively. Despite having worse working conditions than those of steel-reinforced concrete, BRC generally exhibits several encouraging traits. While these studies provide some evidence of the long-term performance of BRC, more research is required to fully understand its behaviour over extended periods of time. Factors such as the exposure to environmental conditions, loading patterns, and maintenance practices can affect the long-term performance of BRC structures.

In summary, investigating the long-term behaviour of BRC is an important aspect of this study. Although studies have shown promising results, further research is required to fully understand the durability and performance of BRC structures over extended periods of time.

## 8. Conclusion

Due to the current energy crisis, scientists and engineers are searching for natural materials to replace steel in the construction industry. One of the most interesting materials is bamboo, which is readily available in tropical regions of the world and has unique qualities such as rapid growth and a high tensile-strength-to-weight ratio. Based on this literature review, it can be concluded that bamboo is an effective and suitable material for replacing steel in concrete. Therefore, it can be used as a reinforcement material for structural members. It is lightweight, sturdy, versatile, and cost efficient. Specifically, the wall constructed using bamboo as reinforcing material was 56% lighter in weight and also 40% cheaper than the brick wall. One of the shortcomings of bamboo is that it degrades more quickly than steel because it is a natural material. Therefore, untreated bamboo should not be used as a reinforcement material. Unlike steel, bamboo requires two phases of preservative treatment before it can be used as reinforcement: first, a chemical preservative to protect against insect and fungal assault, and second, an epoxy coating to make the bamboo waterproof.

However, the preservation of bamboo requires further research so that it does not degrade due to attacks by termites and fungi. Research has shown that many chemical treatments can overcome this problem; however, they are costly. Therefore, the development of less expensive methods is necessary. Further research should be conducted to investigate the durability of BRC members.

Finally, bamboo can absorb carbon dioxide from the atmosphere which helps mitigate global warming. Seizing carbon dioxide from the air is an important means of combating climate change. In addition, bamboo is a fast-growing plant with strong roots that can help prevent landslides and reduce soil erosion. In general, bamboo is advocated as the best, most affordable, and most environment-friendly substitute for steel.

## REFERENCES

- [1] Mondal, B., Maity, D., Patra, P.K.: Tensile characterisation of bamboo strips for potential use in reinforced concrete members: experimental and numerical study, *Materials and Structures/Materiaux et Constructions*, 53 (2020) 5.
- [2] Akwada, D.R., Akinlabi, E.T., Economic, Social and Environmental Assessment of Bamboo for Infrastructure Development, *Proceedings of the International Conference on Infrastructure Development in Africa*, 2016.
- [3] Chow, H.K.: *Bamboo as a material for reinforcing concrete*, Massachusetts Institute of Technology, 1914.
- [4] Glenn, H.E.: *Bamboo reinforcement in Portland cement concrete*, Bulletin No. 4, Engineering Experiment Station, Clemson Agricultural College, Clemson, South Carolina, 1950.
- [5] Brink, F.E., Rush, P.J.: *Bamboo reinforced concrete construction*, 1966.
- [6] American Concrete Institute (ACI): *ACI 318-56 Building code requirements for reinforced concrete*, American Concrete Institute (ACI), Detroit, 1956.
- [7] Geymayer, H.G., Cox, F.B.: *Bamboo reinforced concrete*, *J. Am. Concrete Inst.*, 67 (1970) 51, pp. 841-846
- [8] Kurian, N.P., Kalam, A.K.: *Bamboo reinforced soil-cement for rural use*, *Indian Concrete Journal*, 51 (1977) 12, pp. 382
- [9] Mansur, M., Aziz, M.: *Study of bamboo-mesh reinforced cement composites*, *Int. J. Cem. Compos. Lightweight Concr.*, 5 (1983) 3, pp. 165-171
- [10] Ghavami, K.: *Ultimate load behaviour of bamboo-reinforced lightweight concrete beams*, *Cement and Concrete Composites*, 17 (1995) 4, pp. 281-288
- [11] Kankam, C.K., Odum Ewuakye, B.: *Flexural behaviour of babadua reinforced one-way slabs subjected to third-point loading*, *Construction and Building Materials*, 15 (2001) 1, pp. 27-33
- [12] Kankam, C.K., Odum Ewuakye, B.: *Babadua reinforced concrete two-way slabs subjected to concentrated loading*, *Construction and Building Materials*, 20 (2006) 5, pp. 279-285. <https://doi.org/10.1016/j.conbuildmat.2005.01.021>
- [13] Ghavami, K., *Bamboo as reinforcement in structural concrete elements*, *Cement and Concrete Composites*, 27 (2005) 6, pp. 637-649
- [14] Perera, S.J., Lewangamage, S.C.: *Experimental investigation on flexural behaviour of bamboo reinforced concrete slab panels*, *Proceedings of The IESL 108th annual Transactions*, Sri Lanka, 2015.
- [15] Muda, Z.C., Usman, F., Beddu, S., Alam, M.A., Thiruchelvam, S., Sidek, L.M., Basri, H., Saadi, S.: *Impact resistance performance of green construction material using light weight oil palm shells reinforced bamboo concrete slab*, *IOP Conference Series: Earth and Environmental Science*, 16 (2013). 1, pp. 1-5
- [16] Muda, Z.C., Beddu, S., Syamsir, A., Ating, J.S., Mohd Kamal, N.L., Mustapha, K.N., Thiruchelvam, S., Usman, F., Alam, M.A., Birima, A.H., Zarog, O.S.: *Impact resistance behaviour of light weight rice husk concrete with bamboo reinforcement*, *IOP Conference Series: Earth and Environmental Science*, 32 (2016) 1, pp. 1-5
- [17] Designation: C150/C150M - 16"116"1 Standard Specification for Portland Cement 1, [https://doi.org/10.1520/C0150\\_C0150M-16E01](https://doi.org/10.1520/C0150_C0150M-16E01), 1.1.2021.
- [18] Chithambaram, S.J., Kumar, S.: *Flexural behaviour of bamboo based ferrocement slab panels with fly ash*, *Construction and Building Materials*, 134 (2017), pp. 641-648, <https://doi.org/10.1016/j.conbuildmat.2016.12.205>
- [19] Mali, P.R., Datta, D.: *Experimental evaluation of bamboo reinforced concrete slab panels*, *Construction and Building Materials*, 188 (2018), pp. 1092-1100
- [20] SIST-EN-14488-5-2006: *Testing sprayed concrete Determination of energy absorption capacity of fibre reinforced slab specimens*, 2006.
- [21] Haryanto, Y., Wariyatno, N.G., Hu, H.T., Han, A.L., Hidayat, B.A.: *Investigation on structural behaviour of bamboo reinforced concrete slabs under concentrated load*, *Sains Malaysiana*, 50 (2021) 1, pp. 227-238.
- [22] Mali, P.R., Datta, D.: *Experimental evaluation of bamboo reinforced concrete beams*, *Journal of Building Engineering*, 28 (2019), 101071.
- [23] Kankam, C.K., Odum-Ewuakye, B.: *Flexural strength and behavior of babadua-reinforced concrete beams*, *Journal of Materials in Civil Engineering*, 2000.
- [24] Mark, A.A., Russell, A.O.: *A comparative study of bamboo reinforced concrete beams using different stirrup materials for rural construction*, *International Journal of Civil and Structural Engineering*, 2 (2011) 1, pp. 407-423
- [25] Anto, A., Augustin, A., Ratheesh, R., Belarmin Xavier, C.S.: *Flexural behavior of the untreated plain bamboo reinforced concrete beam under four-point loading*, *Materials Today: Proceedings*, 2023., <https://doi.org/10.1016/j.matpr.2023.03.543>
- [26] Al-Fasih, M.Y., Hamzah, S., Ahmad, Y., Ibrahim, I.S., Mohd Ariffin, M.A.: *Tensile properties of bamboo strips and flexural behaviour of the bamboo reinforced concrete beams*, *European Journal of Environmental and Civil Engineering*, 26 (2022) 13, pp. 6444-6460, <https://doi.org/10.1080/19648189.2021.1945954>
- [27] Budi, A.S., Rahmadi, A.P.: *Flexural behavior of petung bamboo strip notched reinforced concrete beams*, *Journal of Physics: Conference Series*, 1153 (2019) 1, <https://doi.org/10.1088/1742-6596/1153/1/012127>
- [28] Awoyera, P.O., Karthik, S., Rao, P.R.M., Gobinath, R.: *Experimental and numerical analysis of large-scale bamboo-reinforced concrete beams containing crushed sand*, *Innovative Infrastructure Solutions*, 4 (2019) 1, pp. 1-15, <https://doi.org/10.1007/s41062-019-0228-x>
- [29] Leelatanon, S., Srivaro, S., Matan, N.: *Compressive strength and ductility of short concrete columns reinforced by bamboo*, *Songklanakarin J. Sci. Technol*, 32 (2010) 4.
- [30] Akinyemi, B.A., Omoniyi, T.E.: *Repair and strengthening of bamboo reinforced acrylic polymer modified square concrete columns using ferrocement jackets*, *Scientific African*, 8 (2020), pp. 1-9
- [31] Agarwal, A., Nanda, B., Maity, D.: *Experimental investigation on chemically treated bamboo reinforced concrete beams and columns*, *Computers and Chemical Engineering*, 71 (2014), pp. 610-617
- [32] Puri, V., Chakraborty, P., Anand, S., Majumdar, S.: *Bamboo reinforced prefabricated wall panels for low-cost housing*, *Journal of Building Engineering*, 9 (2017), pp. 52-59
- [33] Ganesan, N., Indira, P.V., Himasree, P.R.: *Influence of opening on the behaviour of bamboo reinforced concrete wall panels under two way in-plane action*, *Journal of Structural Engineering (India)*, 45 (2019) 6, pp. 486-496

- [34] Kaushik, H.B., Dasgupta, K., Sahoo, D.R., Kharel, G.: Performance of structures during the Sikkim earthquake of 14 February 2006, *Current Science*, 91 (2006) 4, <https://about.jstor.org/terms>
- [35] González, G., Gutiérrez, J.: Structural performance of bamboo "bahareque" walls under cyclic load, *Journal of Bamboo and Rattan*, 4 (2005) 4, pp. 353-368
- [36] Moroz, J.G., Lissel, S.L., Hagel, M.D.: Performance of bamboo reinforced concrete masonry shear walls, *Construction and Building Materials*, 61 (2014), pp. 125-137, <https://doi.org/10.1016/j.conbuildmat.2014.02.006>
- [37] Indian Standard Specifications for Method of Tests for Split Bamboo, I.S. 8242:1976, Bureau of Indian Standards, New Delhi, India, 1976.
- [38] Bureau of Indian Standards: Indian Standard Specifications for Method of Tests for Bamboo, I.S. 6874:2008, New Delhi, India, 2008.
- [39] Bureau of Indian Standards: Indian Standard Specifications for Code of Practice for Preservation of Bamboo for Structural Purposes, IS 9096:2006, New Delhi, India, 2006.
- [40] Bureau of Indian Standards: Indian Standard Specifications for Code of Practice for Structural Design using Bamboo, IS 15912-2018, New Delhi, India, 2018.
- [41] <https://ars.els-cdn.com/content/image/3-s2.0-B9780081009598000135-f13059780081009598.sml>
- [42] ISO: ISO 22156: 2004 (E), Bamboo – Structural design, Geneva Switzerland, 2004.
- [43] ISO: ISO 22157-1:2004 (E), Bamboo – Determination of physical and mechanical properties – part I: requirements, Geneva, Switzerland, 2004.
- [44] ISO: ISO 19624: 2018 (E), Bamboo structures — Grading of bamboo culms — Basic principles and procedures, Geneva, Switzerland, 2018.
- [45] Dixit, A., Puri, V.: Bamboo bonding in concrete: A critical research, *International Journal of Innovative Technology and Exploring Engineering*, 8 (2019) 11, pp. 323-334
- [46] Subramanian, N.: *Design of Reinforced Concrete Structures*, Oxford University Press, ISBN 13:978-0-19-808694-9, pp. 262-264
- [47] Archila, H., Kaminski, S., Trujillo, D., Zea Escamilla, E., Harries, K. A.: Bamboo reinforced concrete: a critical review, *Materials and Structures*, 51 (2018) 4.
- [48] Mondal, B., Maity, D., Patra, P.K.: Bond behavior between bamboo and normal-strength concrete: experimental and numerical investigation, *Practice Periodical on Structural Design and Construction*, 27 (2022) 3, pp. 1-11
- [49] Mali, P.R., Datta, D.: Experimental study on improving bamboo concrete bond strength, *Advances in Concrete Construction*, 7 (2019) 3, pp. 191-201
- [50] Fang, H.Y., Mehta, H.C.: Sulfur-sand treated bamboo rod for reinforcing structural concrete, *Advances in Chemistry Series*, 165 (1978), pp. 241-254
- [51] Terai, M., Minami, K.: Research and development on bamboo reinforced concrete structure, *WCEE*, 15 (2012)
- [52] Sakaray, H., Vamsi Krishna Togati, N.V., Ramana Reddy, I.V.: Investigation on properties of bamboo as reinforcing material in concrete, *International Journal of Engineering Research and Application*, 2 (2012) Jan-Feb, pp. 77-83
- [53] Kute, S.Y., Wakchaure, M.R.: Performance evaluation for enhancement of some of the engineering properties of bamboo as reinforcement in concrete, *Journal of The Institution of Engineers, Series A*, 94 (2013) 4, pp. 235-242
- [54] Javadian, A., Wielopolski, M., Smith, I.F.C., Hebel D.E.: Bond-behavior study of newly developed bamboo-composite reinforcement in concrete, *Construction and Building Materials*, (2016) 122, pp. 110-117.
- [55] Nindyawati, Umniati, B.S.: Bond strength of bamboo reinforcement in light weight concrete, *Journal of Civil Engineering and Architecture*, 10 (2016), pp. 417-420
- [56] Dey, A., Chetia, N.: Experimental study of Bamboo reinforced concrete beams having various frictional properties, *Materials Today: Proceedings*, 5 (2018).
- [57] Janssen, J.A.: *Designing and Building with Bamboo*, Report No. 20, Beijing, INBAR, 2000.
- [58] Bureau of Indian Standards: Indian Standard Specifications for Methods of Testing Bond in Reinforced Concrete, IS 2770 (Part 1), New Delhi, India, 1997.
- [59] Mulyati, A.: The evaluation of bond strength of bamboo reinforcement in concrete, *Proceedings of the International Conference on Technology, Innovation and Society*, 2016.
- [60] Azadeh, A., Kazemi, H.H.: New approaches to bond between bamboo and concrete, *Key Engineering Materials*, (2014) 600, pp. 69-77
- [61] Moh', A., Khatib, A.: *An Investigation into the Use of Bamboo as Reinforcement in Concrete*, 2020.
- [62] Lima, H.C., Willrich, F.L., Barbosa, N.P., Rosa, M.A., Cunha, B.S.: Durability analysis of bamboo as concrete reinforcement, *Materials and Structures/Materiaux et Constructions*, 41 (2008) 5, pp. 981-989, <https://doi.org/10.1617/s11527-007-9299-9>
- [63] Awolusi, T.F., Ayomikun, P.B., Oluwatobi, G.A.: An Evaluation of the Flexural and Durability Properties of Bamboo-Reinforced Concrete Prism, *Iranian Journal of Science and Technology, Transactions of Civil Engineering*, 46 (2022) 6, pp. 4343-4353